

JVC

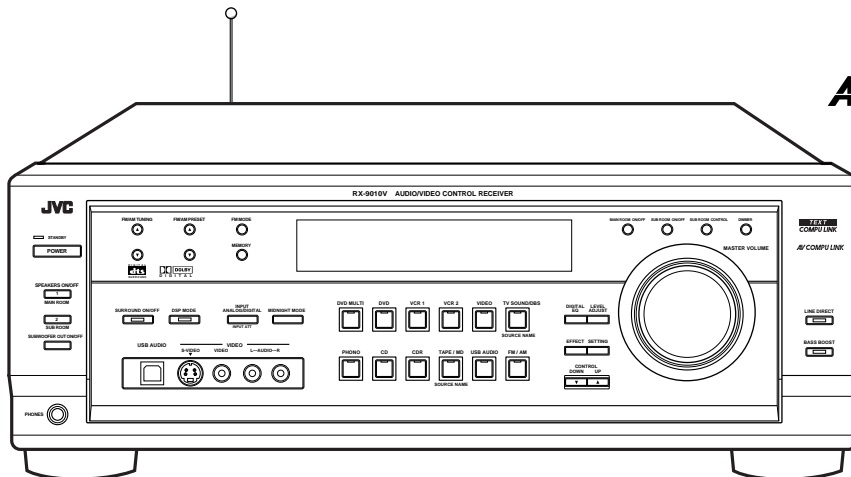

AUDIO/VIDEO CONTROL RECEIVER

RX-9010VBK

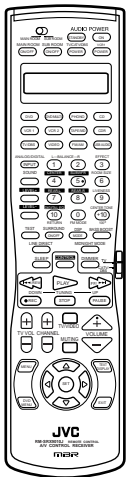

AV COMPU LINK

**TEXT
COMPU LINK**

DIGITAL
dts
SURROUND

DOLBY
DIGITAL

INSTRUCTIONS

For Customer Use:

Enter below the Model No. and Serial No. which are located either on the rear, bottom or side of the cabinet. Retain this information for future reference.



Model No. _____

Serial No. _____

LVT0620-001A

[J]

Warnings, Cautions and Others/ Mises en garde, précautions et indications diverses

	CAUTION RISK OF ELECTRIC SHOCK DO NOT OPEN	
CAUTION: TO REDUCE THE RISK OF ELECTRIC SHOCK, DO NOT REMOVE COVER (OR BACK) NO USER SERVICEABLE PARTS INSIDE. REFER SERVICING TO QUALIFIED SERVICE PERSONNEL.		



The lightning flash with arrowhead symbol, within an equilateral triangle is intended to alert the user to the presence of uninsulated "dangerous voltage" within the product's enclosure that may be of sufficient magnitude to constitute a risk of electric shock to persons.



The exclamation point within an equilateral triangle is intended to alert the user to the presence of important operating and maintenance (servicing) instructions in the literature accompanying the appliance.

WARNING: TO REDUCE THE RISK OF FIRE OR ELECTRIC SHOCK, DO NOT EXPOSE THIS APPLIANCE TO RAIN OR MOISTURE.

CAUTION

To reduce the risk of electrical shocks, fire, etc.:

1. Do not remove screws, covers or cabinet.
2. Do not expose this appliance to rain or moisture.

ATTENTION

Afin d'éviter tout risque d'électrocution, d'incendie, etc.:

1. Ne pas enlever les vis ni les panneaux et ne pas ouvrir le coffret de l'appareil.
2. Ne pas exposer l'appareil à la pluie ni à l'humidité.

Note to CATV system installer:

This reminder is provided to call the CATV system installer's attention to Section 820-40 of the NEC which provides guidelines for proper grounding and, in particular, specifies that the cable ground shall be connected to the grounding system of the building, as close to the point of cable entry as practical.

Caution — POWER switch!

Disconnect the mains plug to shut the power off completely. The POWER switch in any position does not disconnect the mains line. The power can be remote controlled.

Attention — Commutateur POWER!

Déconnecter la fiche de secteur pour couper complètement le courant. Le commutateur POWER ne coupe jamais complètement la ligne de secteur, quelle que soit sa position. Le courant peut être télécommandé.

Caution — SPEAKER LOAD SELECTOR switch!

Match the position of SPEAKER LOAD SELECTOR switch on the back panel to the impedance of the speaker connected, to protect from overheating.

For the main unit:

Declaration of Conformity

Model Number: RX-9010VBK
Trade Name: JVC
Responsible Party: JVC Americas Corp.
Address: 1700 Valley Road, Wayne
New Jersey 07470
Telephone Number: 973-315-5000

This device complies with Part 15 of FCC Rules. Operation is subject to the following two conditions: (1) This device may not cause harmful interference, and (2) this device must accept any interference received, including interference that may cause undesired operation.

Pour l'appareil principal:

Déclaration de conformité

Numéro de modèle: RX-9010VBK
Nom de marque: JVC
Personne responsable: US JVC CORP.
Adresse: 1700 Valley Road
Wayne, N.J. 07470
Numéro de téléphone: (973) 315-5000

Cet ensemble se conforme à la partie 15 des règles de la FCC (Federal Communications Commission), Le fonctionnement est sujet aux deux conditions suivantes:

(1) Cet appareil ne peut pas causer d'interférences nuisibles, et (2) cet appareil doit accepter toute interférence reçue, comprenant des interférences qui peuvent causer un mauvais fonctionnement.

For the main unit:

This equipment has been tested and found to comply with the limits for a Class B digital device, pursuant to part 15 of the FCC Rules. These limits are designed to provide reasonable protection against harmful interference in a residential installation.

This equipment generates, uses and can radiate radio frequency energy and, if not installed and used in accordance with the instructions, may cause harmful interference to radio communications. However, there is no guarantee that interference will not occur in a particular installation. If this equipment does cause harmful interference to radio or television reception, which can be determined by turning the equipment off and on, the user is encouraged to try to correct the interference by one or more of the following measures:

Reorient or relocate the receiving antenna.
Increase the separation between the equipment and receiver.
Connect the equipment into an outlet on a circuit different from that to which the receiver is connected.
Consult the dealer or an experienced radio/TV technician for help.

Changes or modifications not expressly approved by the manufacturer for compliance could void the user's authority to operate the equipment.

For the remote control:

This device complies with Part 15 of the FCC Rules. Operation is subject to the following two conditions: (1) This device may not cause harmful interference, and (2) this device must accept any interference received, including interference that may cause undesired operation.

Changes or modifications not expressly approved by the manufacturer for compliance could void the user's authority to operate the equipment.

For Canada/pour Le Canada

For the main unit / Pour l'appareil principal

THIS DIGITAL APPARATUS DOES NOT EXCEED THE CLASS B LIMITS FOR RADIO NOISE EMISSIONS FROM DIGITAL APPARATUS AS SET OUT IN THE INTERFERENCE-CAUSING EQUIPMENT STANDARD ENTITLED "DIGITAL APPARATUS," ICES-003 OF THE DEPARTMENT OF COMMUNICATIONS. CET APPAREIL NUMERIQUE RESPECTE LES LIMITES DE BRUITS RADIOELECTRIQUES APPLICABLES AUX APPAREILS NUMERIQUES DE CLASSE B PRESCRITES DANS LA NORME SUR LE MATERIEL BROUILLEUR; "APPAREILS NUMERIQUES", NMB-003 EDICTEE PAR LE MINISTRE DES COMMUNICATIONS.

For Canada/pour le Canada

CAUTION: TO PREVENT ELECTRIC SHOCK, MATCH WIDE BLADE OF PLUG TO WIDE SLOT, FULLY INSERT
ATTENTION: POUR EVITER LES CHOCS ELECTRIQUES, INTRODUIRE LA LAME LA PLUS LARGE DE LA FICHE DANS LA BORNE CORRESPONDANTE DE LA PRISE ET POUSSER JUSQU'AU FOND

For the remote control / Pour la télécommande

This device complies with RSS-210 of Industry Canada Rules. Operation is subject to the following two conditions: (1) this device may not cause interference, and (2) this device must accept any interference, including interference that may cause undesired operation of the device.

Cet appareil est conforme au règlement CNR-210 de l'industrie du Canada. L'utilisation de ce dispositif est autorisée seulement aux conditions suivantes: (1) il ne doit pas produire de brouillage et (2) l'utilisateur du dispositif doit être prêt à accepter tout brouillage radioélectrique reçu, même si ce brouillage est susceptible de compromettre le fonctionnement du dispositif.

Caution: Proper Ventilation

To avoid risk of electric shock and fire and to protect from damage.

Locate the apparatus as follows:

- Front: No obstructions open spacing.
- Sides: No obstructions in 10 cm from the sides.
- Top: No obstructions in 10 cm from the top.
- Back: No obstructions in 15 cm from the back
- Bottom: No obstructions, place on the level surface.

In addition, maintain the best possible air circulation as illustrated.

Attention: Ventilation Correcte

Pour éviter les chocs électriques, l'incendie et tout autre dégât.

Disposer l'appareil en tenant compte des impératifs suivants

- Avant: Rien ne doit gêner le dégagement
- Flancs: Laisser 10 cm de dégagement latéral
- Dessus: Laisser 10 cm de dégagement supérieur
- Arrière: Laisser 15 cm de dégagement arrière
- Dessous: Rien ne doit obstruer par dessous; poser l'appareil sur une surface plate.

Veiller également à ce que l'air circule le mieux possible comme illustré.

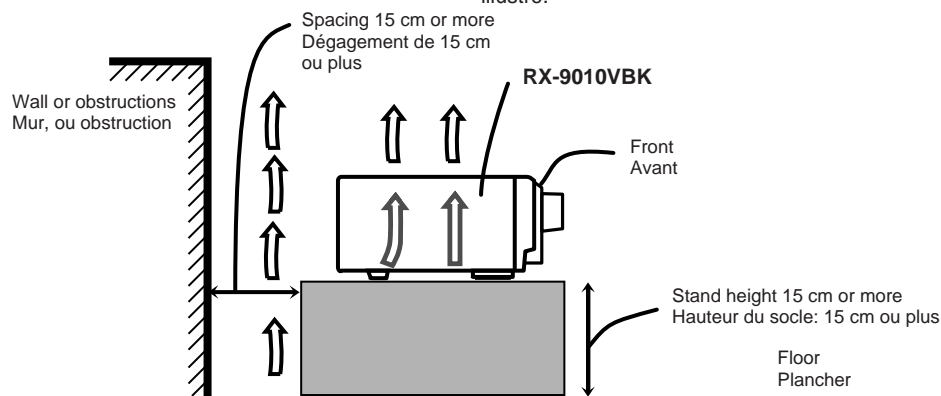

Table of Contents

Introduction	2	Showing the Text Information on the Display	33
Features	2	Basic Setting and Adjustment — Auto Memory	34
Precautions	2	Receiving Radio Broadcasts	35
Parts Identification	3	Tuning in Stations Manually	35
Getting Started	5	Using Preset Tuning	35
Before Installation	5	Selecting the FM Reception Mode	36
Checking the Supplied Accessories	5	Creating a Surround Field in the Main Room	37
Connecting the FM and AM Antennas	5	Reproducing the Sound Field	38
Connecting the Speakers	6	Available DSP Modes According to the Speaker Arrangement	39
Connecting Audio/Video Components	7	Adjusting the Surround Modes	40
■ Analog Connections	7	Adjusting the DAP Modes	41
■ Digital Connections	10	Adjusting the Surround Modes with the DAP Modes	43
■ USB Connection	11	Adjusting the 5 CH/4 CH Stereo Mode	46
Setting Up the RF Rod Antenna	12	Adjusting the 3D-PHONIC Modes	47
Setting Up the IR Signal Transmitter	12	Using the DVD MULTI Playback Mode	49
Connecting the Power Cord	13	Activating the DVD MULTI Playback Mode	49
Putting Batteries in the Remote Control	13	Using the On-Screen Menus	50
Multi-room Operations	14	■ Showing the MENU on the TV Screen	50
Basic Operating Procedure for Main Room	15	■ Activating the Surround Modes	50
Basic Operating Procedure for Sub-Room	16	■ Activating the DAP Modes	50
Main Room Basic Operations	17	■ Selecting the Analog or Digital Input Mode	50
Turning the Power On and Off (Standby)	17	■ Adjusting the Equalization Patterns	51
Canceling the Main Room Operations	18	■ Adjusting the Surround and DSP Modes	51
Selecting the Main Room Source to Play	18	■ Adjusting the DVD MULTI Playback Mode	52
Adjusting the Main Room Volume	19	■ Listening at Night — Midnight Mode	52
Activating the Main Room Front Speakers	19	■ Attenuating the Input Signal	52
Adjusting the Equalization Patterns	20	■ Selecting the Line Direct Function	53
Listening at Night — Midnight Mode	21	■ Selecting the Bass Boost Function	53
Activating the Subwoofer Sound	21	■ Activating the Subwoofer Sound	53
Reinforcing the Bass	21	■ Operating the Tuner	53
Muting the Main Room Sound	21	■ Storing the Preset Stations	54
Attenuating the Input Signal	21	■ Setting the Basic Setting Items	54
Selecting the Line Direct Function	22	COMPU LINK Remote Control System	55
Changing the Display Brightness	22	TEXT COMPU LINK Remote Control System ..	57
Using the Sleep Timer	22	■ Showing the Disc Information on the TV Screen	58
Recording a Source	22	■ Searching for a Disc (Only for the CD player)	59
Sub-Room Operations	23	■ Entering the Disc Information	60
Turning the Power On and Off (Standby) and Selecting the Sub-room Operations	23	AV COMPU LINK Remote Control System ...	62
Canceling the Sub-room Operations	24	Operating JVC's Audio/Video Components ...	65
Selecting the Sub-room Source to Play	25	Operating Audio Components	65
Adjusting the Sub-room Volume	25	Operating Video Components	67
Activating the Sub-room Front Speakers	26	Operating Other Manufacturers' Equipment ...	68
Muting the Sub-room Sound	26	Troubleshooting	72
Operating the Playback Source for the Sub-room	26	Specifications	74
Basic Settings	27		
Setting the Front Speakers Either for the Main Room or Sub-room	27		
Adjusting the Front Speaker Output Balance	27		
Setting the Subwoofer Information	28		
Adjusting the Subwoofer Output Level	28		
Setting the Speakers for a Surround Field	29		
Digital Input (DIGITAL IN) Terminal Setting	30		
Selecting the Analog or Digital Input Mode	31		
Selecting the Video Input Terminal	32		
Changing the Source Name	33		

You can use "On-screen Menu" for most of the main room operations. For details, see page 50.



Indicates the functions YOU CAN ALSO USE when the receiver is ready for the sub-room operations.

Introduction

*We would like to thank you for purchasing one of our JVC products.
Before operating this unit, read this manual carefully and thoroughly to obtain the best possible performance
from your unit, and retain this manual for future reference.*

Features

Dolby Digital Decoder Incorporated

You can enjoy Dolby Digital, one of the most advanced home theater sound systems available. Dolby Digital, with five full-range channels and a LFE (subwoofer) channel, lets you enjoy the most spectacular theater sound at home when you view movies on DVD.

Compatible with DTS Digital Surround

The RX-9010VBK is compatible with DTS Digital Surround as well. DTS Digital Surround is the digital movie soundtrack format that delivers 5.1-channel audio like Dolby Digital. Using a low audio-data compression rate, it features natural, solid and clear sound.

Multi-room Operations

You can connect two pairs of the front speakers to the RX-9010VBK, and use them to listen to different sources in the different rooms (Main room and Sub-room) at the same time.

RF/IR Multi-brand Remote Control

The remote control sends out not only IR (infrared) signals but also RF (radio frequency) signals as coded commands to control the receiver. The RF rod antenna can receive the RF (Radio Frequency) signals sent from the remote control to operate the receiver. In addition, the supplied RF signal transmitter can transmit IR signals which could control other video components.

- The remote control provided for this receiver can transmit control signals for many manufacturers' components.

COMPU LINK Remote Control System

The COMPU LINK remote control system allows you to operate other JVC audio components from this receiver.

TEXT COMPU LINK Remote Control System

The TEXT COMPU LINK remote control system has been developed to deal with the disc information recorded on the CD Text and MDs. Using this information on the discs, you can operate the CD player or MD recorder through the receiver.

AV COMPU LINK Remote Control System

The AV COMPU LINK remote control system allows you to operate other JVC video components from this receiver.

Precautions

Power sources

- When unplugging the receiver from the wall outlet, always pull the plug, not the AC power cord.
- Do not handle the AC power cord with wet hands.
- If you are not going to operate the receiver for an extended period of time, unplug the AC power cord from the wall outlet.

Multi-room operations

- Do not use the remote control outdoors or install the speakers outdoors.
- When operating the receiver from the place where you cannot see the receiver (for example, when controlling the receiver installed in the living room from the kitchen), pay attention to the following not to surprise other people:
 - Be careful not to turn up the volume so high when controlling the receiver without listening to the playback sound.
 - Be careful not to surprise other people with a sudden sound coming out of the receiver when turning it on. (A sudden stop of the sound may also surprise other people.)
- If the receiver operates by itself or malfunctions, the following causes will be considered:
 - Interference to RF communication between the receiver and the remote control from outside.
 - The remote control is operated unintentionally. For example, a book is placed on the remote control, possibly, depressing some buttons on the remote control.
- If your neighbour uses the same or similar RF remote control system, the receiver may happen to receive the RF signals sent from such an RF remote control system, which could cause your receiver to be operated unintentionally. If this happens, stop using the RF rod antenna and the remote control, and consult your JVC dealer or the nearest JVC Service Center.

Others

- Should any metallic object or liquid fall into the unit, unplug the unit and consult your dealer before operating any further.
- Do not disassemble the unit since there are no user serviceable parts inside.

If anything goes wrong, unplug the AC power cord and consult your JVC dealer.

Parts Identification

Refer to the pages in parentheses for details.

Front Panel

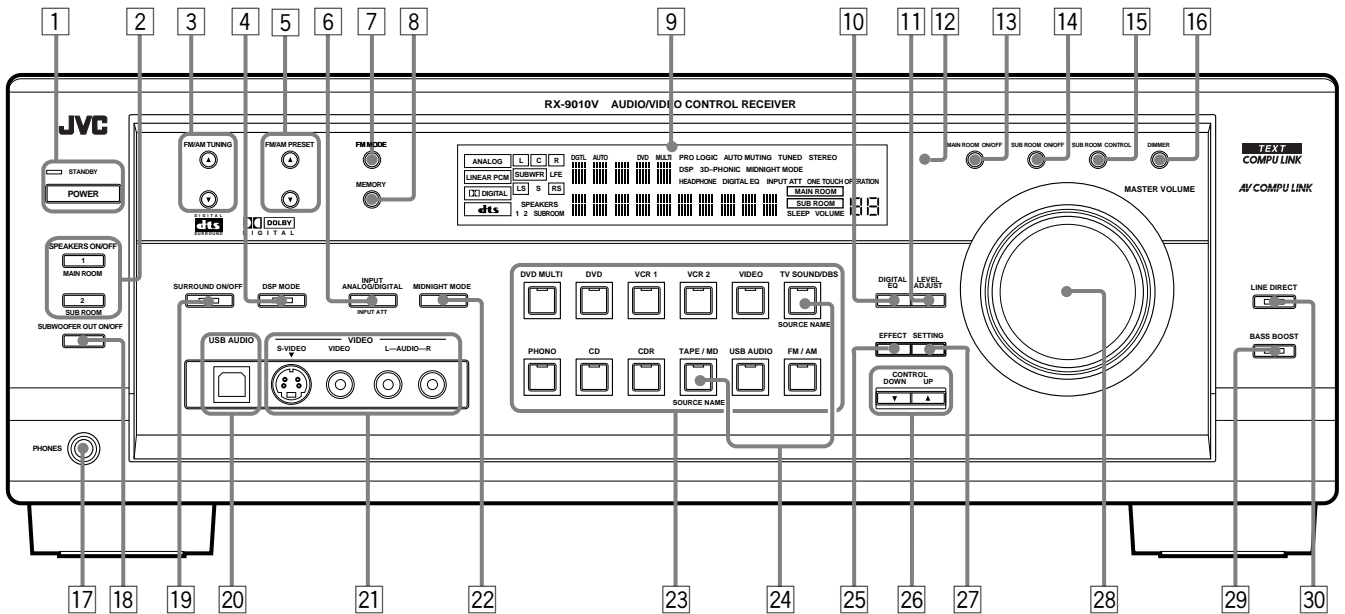

- | | |
|--|--|
| <p>1 POWER button and STANDBY lamp (15 – 17, 23)</p> <p>2 • SPEAKERS ON/OFF 1 (MAIN ROOM) buttons (15, 20)
• SPEAKERS ON/OFF 2 (SUB ROOM) buttons (15, 20, 26)</p> <p>3 FM/AM TUNING ▲/▼ buttons (35)</p> <p>4 DSP MODE button and lamp (42, 45, 46)</p> <p>5 FM/AM PRESET ▲/▼ buttons (35, 36)</p> <p>6 • INPUT ANALOG/DIGITAL button (31)
• INPUT ATT button (21)</p> <p>7 FM MODE button (36)</p> <p>8 MEMORY button (35, 36)</p> <p>9 Display (17, 18, 23, 25)</p> <p>10 DIGITAL EQ button (20)</p> <p>11 LEVEL ADJUST button (27, 28, 41, 45, 46, 48, 49)</p> <p>12 Remote sensor (13)</p> <p>13 MAIN ROOM ON/OFF button (18)</p> <p>14 SUB ROOM ON/OFF button (16, 23, 24)</p> <p>15 SUB ROOM CONTROL button (16, 23, 24)</p> <p>16 DIMMER button (22)</p> | <p>17 PHONES jack (20)</p> <p>18 SUBWOOFER OUT ON/OFF button (21)</p> <p>19 SURROUND ON/OFF button and lamp (41, 45)</p> <p>20 USB AUDIO terminal (11)</p> <p>21 VIDEO input terminals (9)</p> <p>22 MIDNIGHT MODE button (21)</p> <p>23 Source selecting buttons and lamps (18, 25)
DVD MULTI, DVD, VCR 1, VCR 2, VIDEO,
TV SOUND/DBS, PHONO, CD, CDR, TAPE/MD, USB
AUDIO, FM/AM</p> <p>24 SOURCE NAME buttons (33)</p> <p>25 EFFECT button (41, 42, 45 – 48)</p> <p>26 CONTROL UP ▲/DOWN ▼ buttons
(20, 27 – 34, 41, 42, 45 – 49)</p> <p>27 SETTING button (27 – 34)</p> <p>28 MASTER VOLUME control (15, 16, 19, 25)</p> <p>29 BASS BOOST button and lamp (21)</p> <p>30 LINE DIRECT button and lamp (22)</p> |
|--|--|

Remote Control

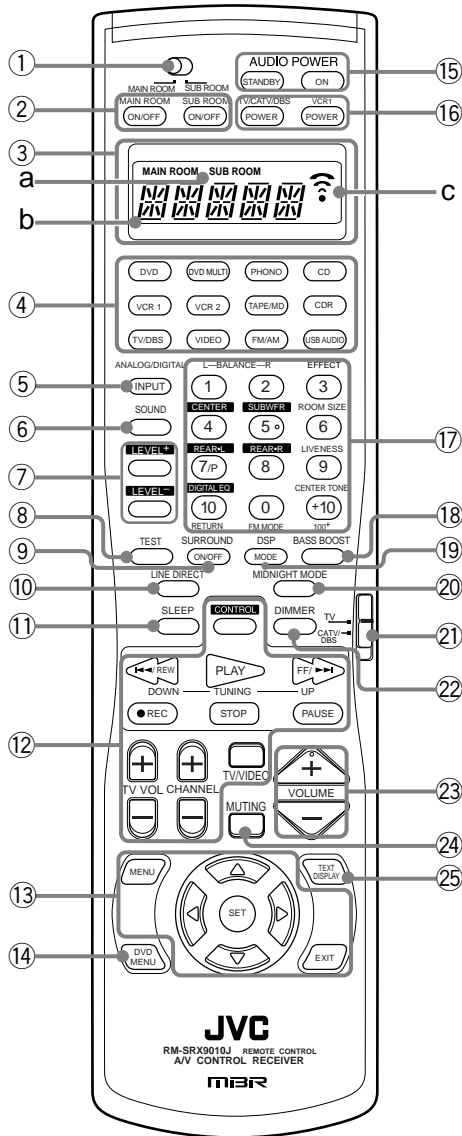

- ① MAIN ROOM/SUB ROOM selector (15 – 17, 23, 24)
- ② MAIN ROOM ON/OFF button (18)
SUB ROOM ON/OFF button (24)
- ③ Display window (17, 23, 27, 40, 49, 50, 58, 65, 67, 68)
 - a. MAIN ROOM/SUB ROOM indicators
 - b. Remote control mode operation indicator
 - c. Signal transmission indicator
Lights up when transmitting the remote control signals.
- ④ Source selecting buttons (18, 25)
DVD, DVD MULTI, PHONO, CD, VCR 1, VCR 2, TAPE/MD, CDR, TV/DBS, VIDEO, FM/AM, USB AUDIO
- ⑤ ANALOG/DIGITAL INPUT button (32)
- ⑥ SOUND button (20, 28, 40, 43, 44, 46 – 49, 65)
- ⑦ LEVEL +/LEVEL – buttons (20, 28, 40, 43, 44, 47 – 49)
- ⑧ TEST button (40, 44)
- ⑨ SURROUND ON/OFF button (39, 40, 44)
- ⑩ LINE DIRECT button (22)
- ⑪ SLEEP button (22)
- ⑫ Operating buttons for audio/video components (35, 65 – 70)
- ⑬ On-screen operation buttons
MENU, SET, EXIT, △, ▽, ◀, ▶ (50, 58, 67, 70)
- ⑭ DVD MENU button (67, 70)
- ⑮ AUDIO POWER buttons
STANDBY, ON (15 – 17, 24)
- ⑯ AUDIO POWER buttons
TV/CATV/DBS POWER, VCR 1 POWER (67 – 70)
- ⑰ • 10 keys for selecting preset channels (36)
• 10 keys for adjusting sound
(20, 28, 36, 40, 41, 43 – 45, 47 – 49, 65)
• 10 keys for operating audio/video components
(65 – 70)
- ⑱ BASS BOOST button (21)
- ⑲ DSP MODE button (43, 44, 47, 48)
- ⑳ MIDNIGHT MODE button (21)
- ㉑ TV/CATV/DBS selector (67, 68)
- ㉒ DIMMER button (22)
- ㉓ VOLUME +/- button (15, 16, 19, 25)
- ㉔ MUTING button (21, 26)
- ㉕ TEXT DISPLAY button (58)

Getting Started

This section explains how to connect audio/video components and speakers to the receiver, and how to connect the power supply.

Before Installation

General

- Be sure your hands are dry.
- Turn the power off to all components.
- Read the manuals supplied with the components you are going to connect.

Locations

- Install the receiver in a location that is level and protected from moisture.
- The temperature around the receiver must be between -5°C and 35°C (23°F and 95°F).
- Make sure there is good ventilation around the receiver. Poor ventilation could cause overheating and damage the receiver.

Handling the receiver

- Do not insert any metal object into the receiver.
- Do not disassemble the receiver or remove screws, covers, or cabinet.
- Do not expose the receiver to rain or moisture.

Checking the Supplied Accessories

Check to be sure you have all of the following items, which are supplied with the receiver.

The number in the parentheses indicates quantity of the pieces supplied.

- Remote Control (1)
- Batteries (2)
- AM Loop Antenna (1)
- FM Antenna (1)
- RF Rod Antenna (1)
- IR Signal Transmitter (1)

If anything is missing, contact your dealer immediately.

Connecting the FM and AM Antennas

FM Antenna Connections

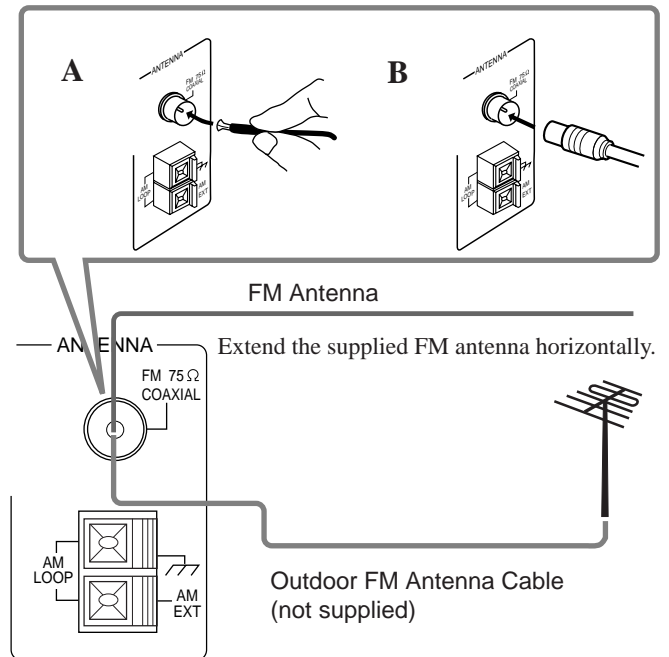

A. Using the Supplied FM Antenna

The FM antenna provided can be connected to the FM 75Ω COAXIAL terminal as a temporary measure.

B. Using the Standard Type Connector with Outdoor FM Antenna (Not Supplied)

A standard type connector should be connected to the FM 75Ω COAXIAL terminal.

Note:

If reception is poor, connect the outdoor antenna. Before attaching a 75Ω coaxial cable (the kind with a round wire going to an outdoor antenna), disconnect the supplied FM antenna.

AM Antenna Connections

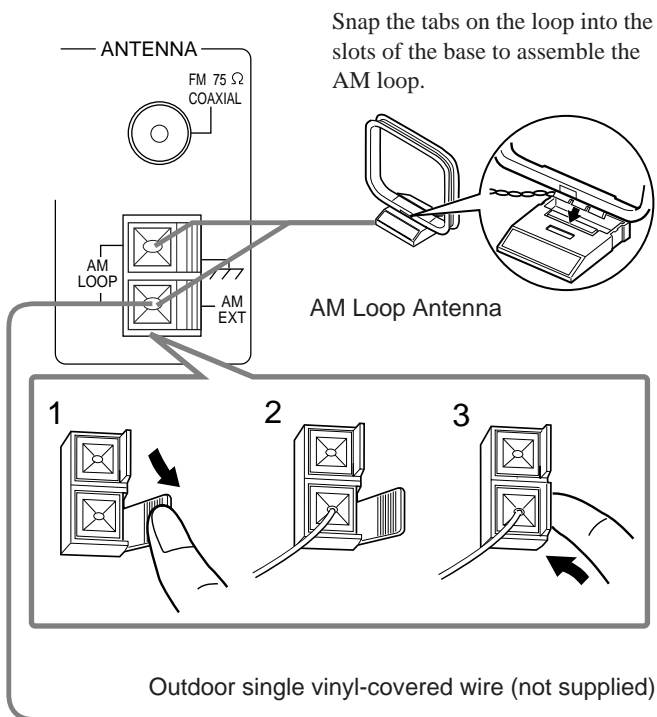

Turn the loop until you have the best reception.

Notes:

- If the AM loop antenna wire is covered with vinyl, remove the vinyl by twisting it as shown in the diagram.
- Make sure the antenna conductors do not touch any other terminals, connecting cords and power cord. This could cause poor reception.
- If reception is poor, connect an outdoor single vinyl-covered wire to the AM EXT terminal. (Keep the AM loop antenna connected.)



Connecting the Speakers

You can connect the following speakers:

- Two pairs of front speakers to produce normal stereo sound.
- One pair of rear speakers to enjoy the surround effect.
- One center speaker to produce more effective surround effect (to emphasize human voices).
- One powered subwoofer to enhance the bass.

IMPORTANT:

After connecting the speakers listed above, set the speaker setting information properly:

- To obtain the best possible Surround and DSP effect in the main room, see page 29.
- To use the Multi-room function, see “Setting the Front Speakers Either for the Main Room or Sub-room” on page 27.

For each speaker (except for a subwoofer), connect the (+) and (–) terminals on the rear panel to the (+) and (–) terminals marked on the speakers. For connecting a subwoofer, see page 7.

CAUTION:

Use speakers with the SPEAKER IMPEDANCE indicated by the speaker terminals.

Basic connecting procedure

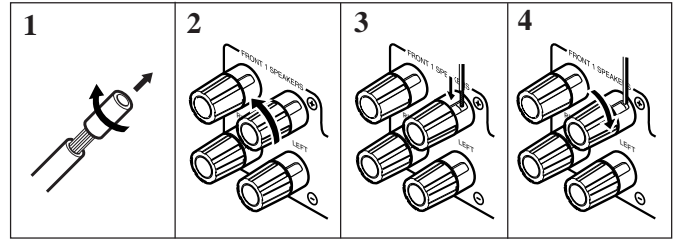

- 1 Cut, twist and remove the insulation at the end of each speaker signal cable (not supplied).
- 2 Turn the knob counterclockwise.
- 3 Insert the speaker signal cable.
- 4 Turn the knob clockwise.

Connecting the front speakers

You can connect two pairs of front speakers — one pair to the FRONT 1 SPEAKERS terminals, and the other pair to the FRONT 2 / SUB ROOM SPEAKERS terminals.

The speakers connected to the FRONT 2 / SUB ROOM SPEAKERS terminals can be used as follows:

- As the second front speakers in the main listening room
- As the main speakers in the sub listening room when using the Multi-room function.

Right speaker — FRONT 1 SPEAKERS — Left speaker

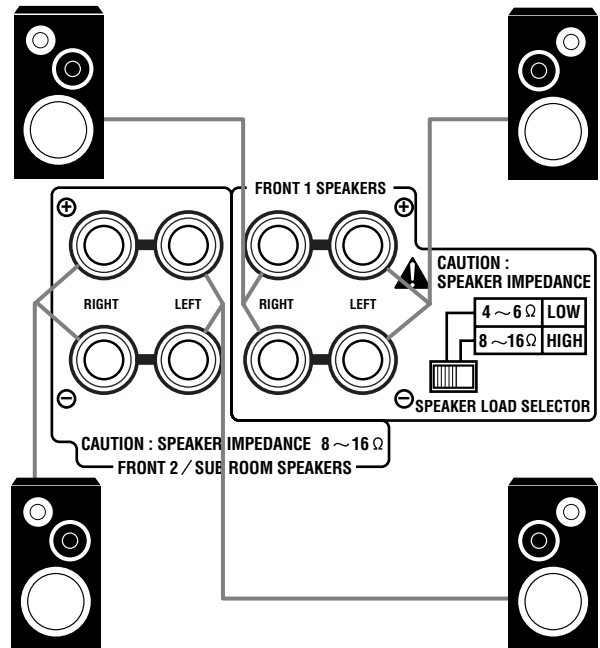

Right speaker — FRONT 2 / SUB ROOM SPEAKERS — Left speaker

IMPORTANT for FRONT 1 SPEAKERS connection:

To obtain the best possible output power from the receiver, and to prevent the receiver from being overheated, the receiver has the SPEAKER LOAD SELECTOR which has to be set as follows:

- Set it to the “HIGH” position when the impedance of the front speakers connected is within the range of 8 Ω to 16 Ω.
- Set it to the “LOW” position when the impedance of the front speakers connected is within the range of 4 Ω to 6 Ω.

Connecting the rear and center speakers

Connect rear speakers to the REAR SPEAKERS terminals and a center speaker to the CENTER SPEAKER terminals.

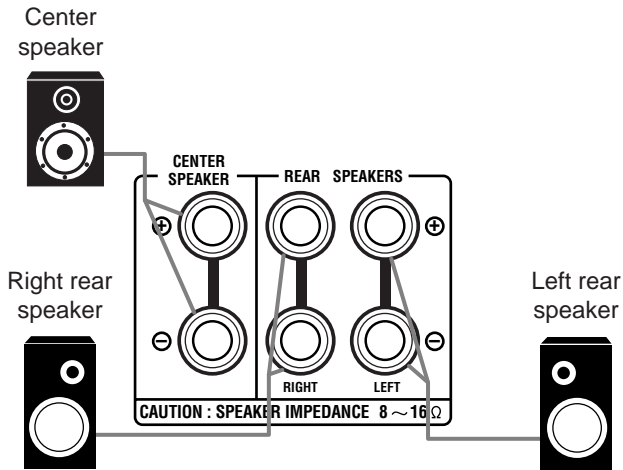

Connecting the subwoofer speaker

You can enhance the bass by connecting a subwoofer. Connect the input jack of a powered subwoofer to the SUBWOOFER OUT jack on the rear panel, using a cable with RCA pin plugs (not supplied).



Powered subwoofer

Connecting Audio/Video Components

You can connect the following audio/video components to this receiver. Refer also to the manuals supplied with your components.

Audio Components	Video Components
• Turntable	• DVD player*
• CD player*	• TV*
• Cassette deck or MD recorder*	• DBS tuner*
• CD recorder*	• VCR(s)
• Personal Computer (PC)	• Video camera

* You can connect these components using the methods described in "Analog connections" (to the right) or in "Digital connections" (see page 10).

Analog Connections

Audio component connections

Use the cables with RCA pin plugs (not supplied).

Connect the white plug to the audio left jack, and the red plug to the audio right jack.

CAUTION:

If you connect a sound-enhancing device such as a graphic equalizer between the source components and this receiver, the sound output through this receiver may be distorted.

Turntable

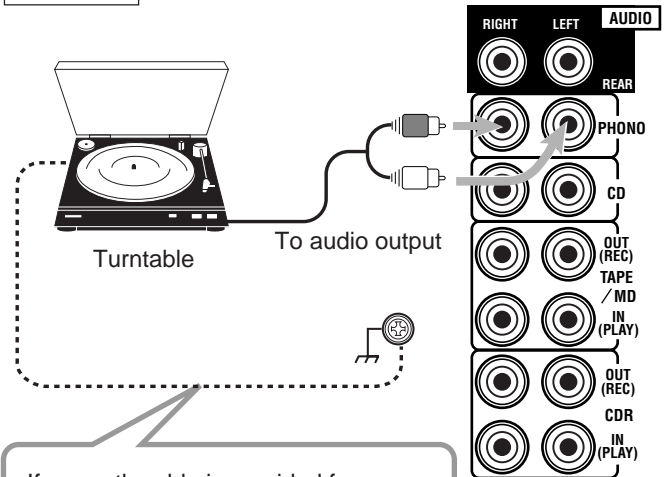

If an earth cable is provided for your turntable, connect the cable to the screw marked (⏚) on the rear panel.

Ex. This connection is for the turntable with an MM (moving-magnet) type cartridge.

Note:

Any turntables incorporating a small-output cartridge such as an MC (moving-coil) type must be connected to this receiver through a commercial head amplifier or step-up transformer. Direct connection may result in insufficient volume.

CD player

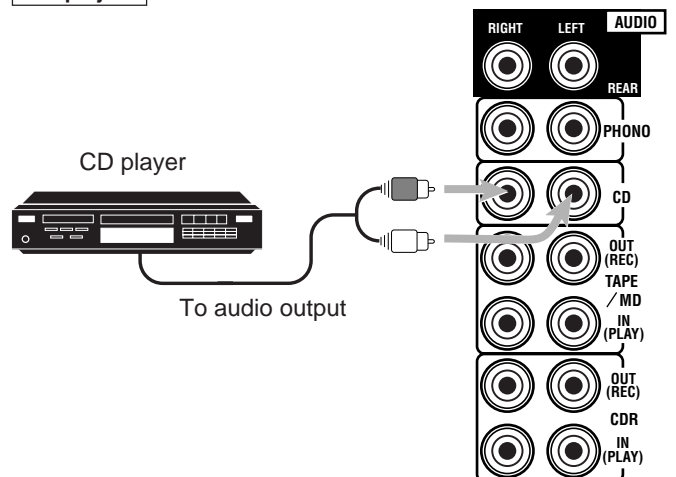

Cassette deck or MD recorder

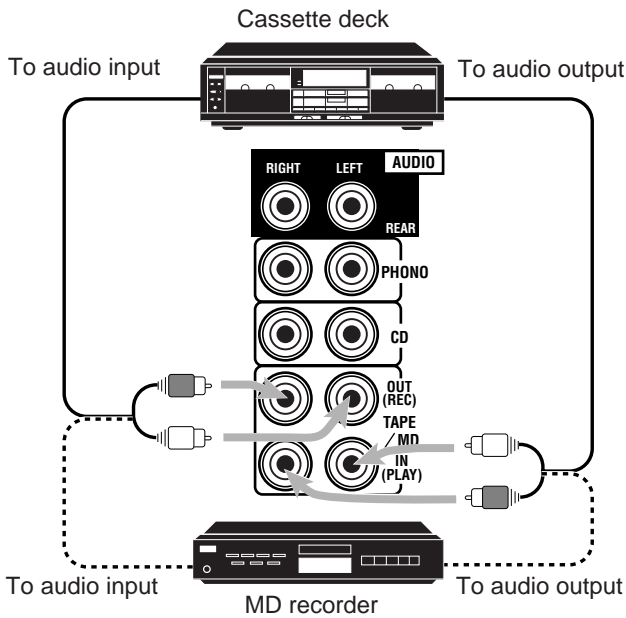

Note:

You can connect either a cassette deck or an MD recorder to the TAPE/MD jacks. When connecting an MD recorder to the TAPE/MD jacks, change the source name, which will be shown on the display when selected as the source, to "MD." See page 33 for details.

CD recorder

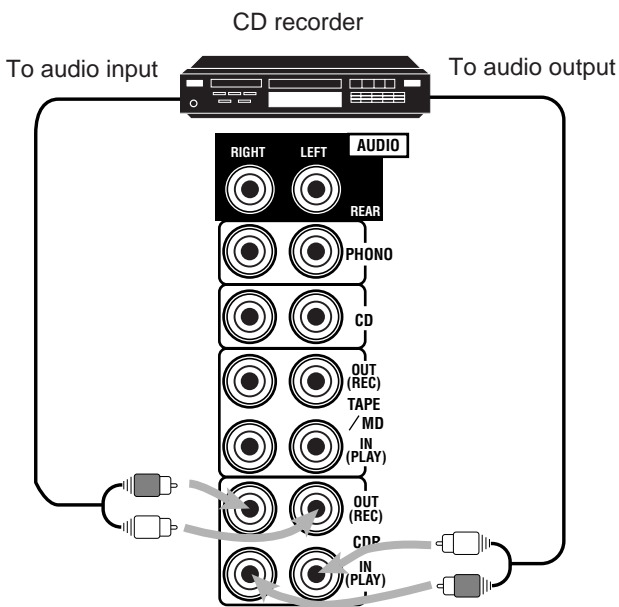

If your audio components have a COMPU LINK or TEXT COMPU LINK jack

- See page 55 for detailed information about the connection and the COMPU LINK remote control system.
- See page 57 for detailed information about the connection and the TEXT COMPU LINK remote control system.

Video component connections

Use the cables with RCA pin plugs (not supplied).

Connect the white plug to the audio left jack, the red plug to the audio right jack, and the yellow plug to the video jack.

- If your video components have S-video (Y/C-separation) and/or component video (Y, P_B/C_B, P_R/C_R) jacks, connect them using an S-video cable (not supplied) and/or component video cable (not supplied). By using these jacks, you can get a better picture quality — in the order : Component video > S-video > Composite video.

IMPORTANT:

This receiver is equipped with the following video jacks — composite video, S-video and component video jacks. You can use any of the three to connect a video component.

However, **remember that the video signals from one type of these input jacks are output only through the video output jacks of the same type.**

Therefore, if a recording video component and a playing video component are connected to the receiver through the different video jacks, you cannot record the picture from the playing component on the recording component. In addition, if the TV and a playing video component are connected to the receiver through the different video jacks, you cannot view the playback picture from the playing component on the TV.

VCR(s)

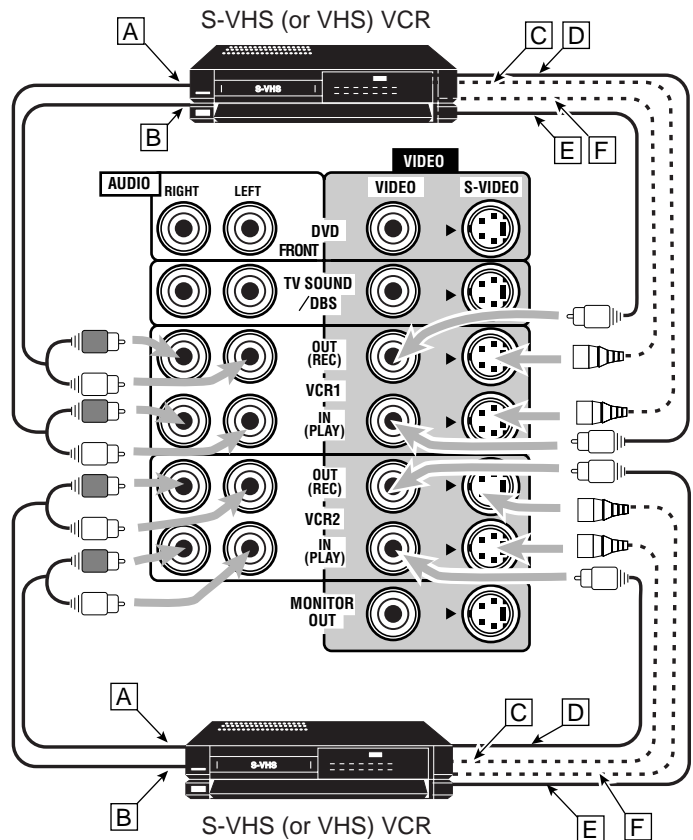

- A To left/right channel audio output
- B To left/right channel audio input
- C To S-video output
- D To composite video output
- E To composite video input
- F To S-video input

TV and/or DBS tuner

When connecting the TV to the AUDIO jacks (TV SOUND/DBS), DO NOT connect the TV's video output to these video input jacks.

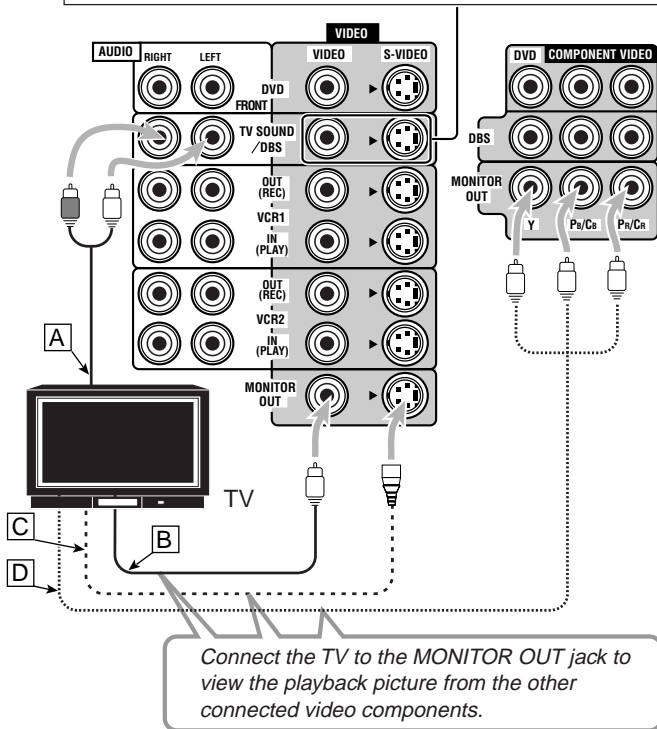

- A To audio output
- B To composite video input
- C To S-video input
- D To component video input

Video camera

The VIDEO input jacks on the front panel are convenient when connecting and disconnecting the equipment frequently.

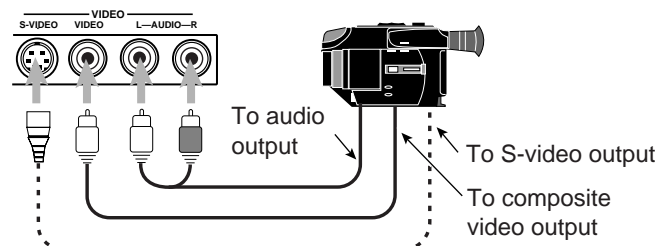

DVD player

When you connect the DVD player with stereo output jacks:

- A To front left/right channel audio output (or to audio mixed output if necessary)
- B To composite video output
- C To S-video output
- D To component video output

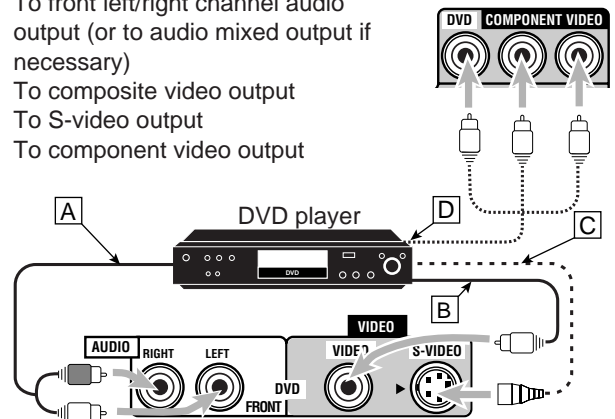

When you connect the DVD player with its analog discrete output (5.1 CH reproduction) jacks:

- A To subwoofer output
- B To center channel audio output
- C To rear left/right channel audio output
- D To front left/right channel audio output
- E To composite video output
- F To S-video output
- G To component video output

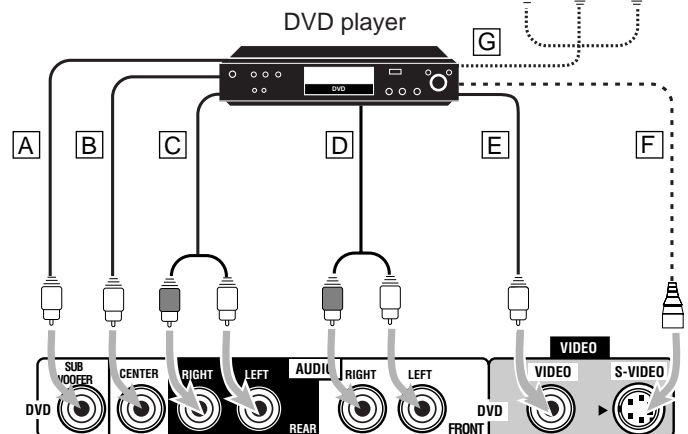

Note:

When operating the DVD player by using the AV COMPU LINK remote control system, change the video input terminal setting correctly. See page 32 for details.

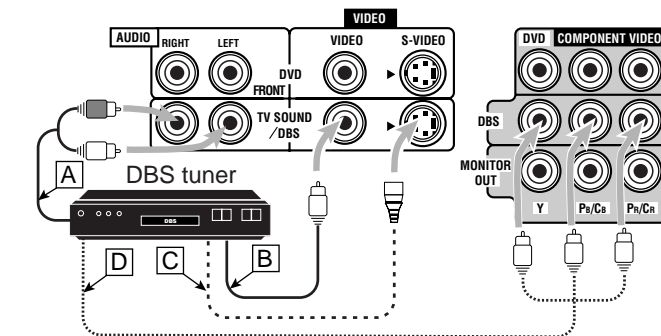

- A To audio output
- B To composite video output
- C To S-video output
- D To component video output

Notes:

- When connecting the DBS tuner to the TV SOUND/DBS jacks, change the source name, which will be shown on the display when selected as the source, to "DBS." See page 33 for details.
- When operating the DBS tuner by using the AV COMPU LINK remote control system, change the video input terminal setting correctly. See page 32 for details.

Digital Connections

This receiver is equipped with four DIGITAL IN terminals — one digital coaxial terminal and three digital optical terminals — and one DIGITAL OUT terminal.

IMPORTANT:

- When connecting the DVD player, digital TV broadcast tuner or DBS tuner using the digital terminals, you also need to connect it to the video terminal on the rear. Without connecting it to the video terminal, you can view no playback picture.
- After connecting the components using the DIGITAL IN terminals, set the following correctly if necessary.
 - Set the digital input (DIGITAL IN) terminal setting correctly. For details, see “Digital Input (DIGITAL IN) Terminal Setting” on page 30.
 - Select the digital input mode correctly. For details, see “Selecting the Analog or Digital Input Mode” on page 31.

Notes:

- When shipped from the factory, the DIGITAL IN terminals have been set for use with the following components:
 - DIGITAL 1 (coaxial): For DVD player
 - DIGITAL 2 (optical): For CD player
 - DIGITAL 3 (optical): For digital TV broadcast tuner
 - DIGITAL 4 (optical): For CD recorder
- When you want to operate the CD player, CD recorder, or MD recorder using the COMPU LINK remote control system, connect the target component also as described in “Analog connections” (see pages 7 and 8).
- When you want to operate the DVD player using the AV COMPU LINK remote control system, connect the DVD player also as described in “Analog connections” (see page 9).
- To use the digital source components as the sub-room source, you need to connect them using analog connection methods as well.

Digital input terminals

You can connect any digital equipment as follows:

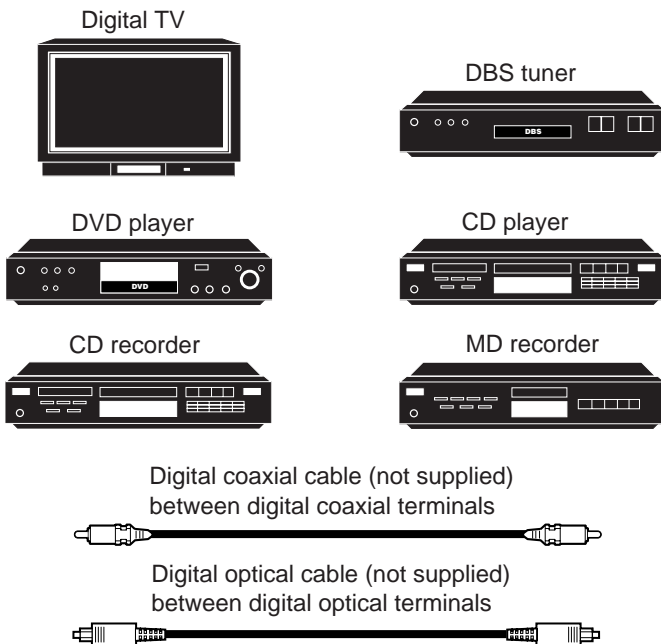

Digital output terminal

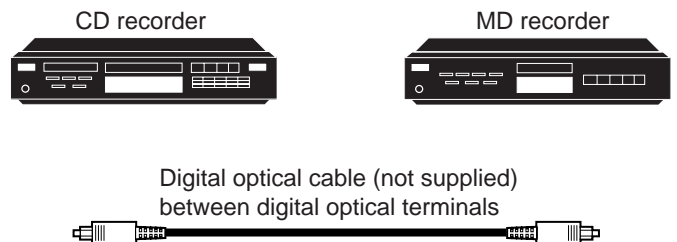

When the digital recording equipment such as an MD recorder and a CD recorder has a digital optical input terminal, connecting it to the DIGITAL OUT terminal enables you to perform digital-to-digital recording.

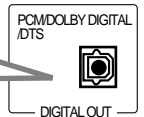

When the component has a digital coaxial output terminal, connect it to the DIGITAL 1 (DVD) terminal, using the digital coaxial cable (not supplied).

When the component has a digital optical output terminal, connect it to the DIGITAL 2 (CD), DIGITAL 3 (TV) or DIGITAL 4 (CDR) terminal, using the digital optical cable (not supplied).

Before connecting a digital optical cable, unplug the protective plug.

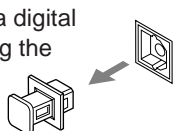

Note:

The digital signal format output through the DIGITAL OUT terminal is the same as that of the input signal. This means that when the DTS Digital Surround signals are input, the DTS Digital Surround signals are output.

USB Connection

This receiver is equipped with a USB terminal on the front panel. You can connect your PC to this terminal and enjoy sound reproduced through your PC.

When you connect your PC for the first time, follow the procedure below.

- Remember you cannot send any signal or data to your PC from this receiver.

IMPORTANT

- Check if your PC equipped with the CD-ROM drive is running on Windows® 98*, Windows® Me*, or Windows® 2000* and prepare its CD-ROM.
- Check your PC's BIOS setting — whether USB is available, and whether USB IRQ is set to "AUTO" or to available IRQ number.

How to install the USB drivers

The following procedure is described using the English version of Windows® 98. If your PC is running on a different version of Windows, the screens shown on your PC's monitor will differ from the ones used in the following procedure.

1. Turn on your PC and start running Windows® 98, Windows® Me or Windows® 2000.

If the PC has been turned on, quit all the applications now running.

2. Turn on the receiver, and press USB AUDIO on the front panel or USB on the remote control.

The lamp on the USB AUDIO button lights up.

3. Connect the receiver to the PC using a USB cable (not supplied).

Your PC automatically recognizes this connection, and shows the following screen on the monitor.

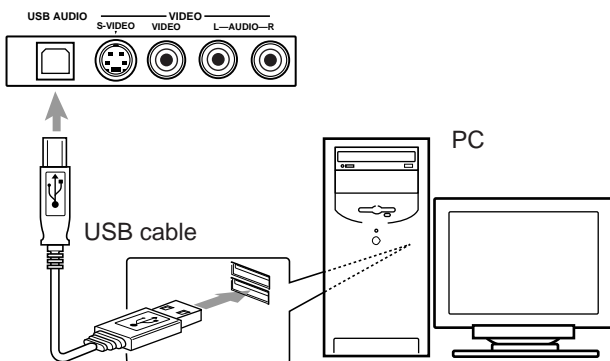

4. Install the USB drivers following the instructions on the PC's monitor.

5. Check if the drivers are correctly installed.

- Open the Control Panel on your PC: Select [Start] → [Settings] → [Control Panel]
- Click [System] → [Device Manager] → [Sound, video and game controllers] and [Universal Serial Bus controllers]. The following window appears, and you can check whether the drivers are installed.

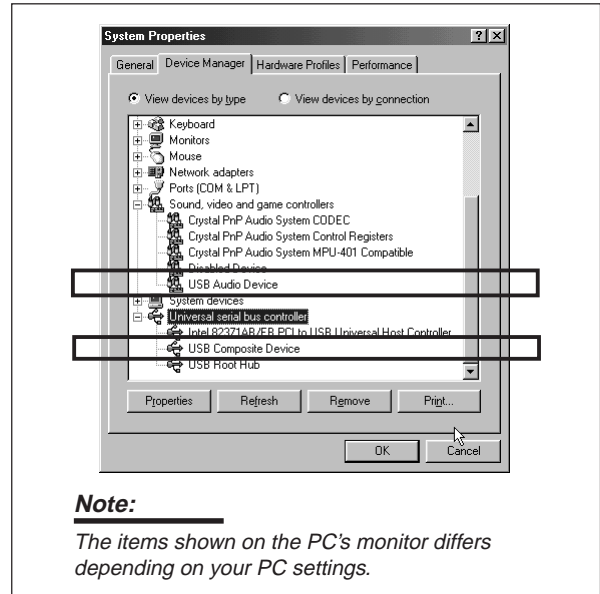

6. Change the PC audio setting.

- If you have closed Control Panel, open it again: Select [Start] → [Setting] → [Control Panel]
- Click [Multimedia Properties], then select "USB Audio Device [1]" for "Playback" of "Audio," and close the window.

To play back a CD from CD-ROM drive on PC, click [Multimedia], [CD Music], then check [Enable digital CD audio for this CD-ROM device].

Now PC is ready for playback through the USB connection.

After installation is completed, you can use your PC as the playback source. The PC automatically recognizes the receiver whenever a USB cable is connected to the PC and the receiver while the receiver is turned on.

- When not using the PC as the playback source, disconnect the USB cable.

To play back sounds on the PC, refer to the manuals supplied with the sound reproduction application installed in the PC.

Notes:

- DO NOT turn off the receiver or disconnect the USB cable while installing the drivers and for a several seconds each time your PC is recognizing the receiver.
- Use a full speed USB cable (revision 1.0).
- If your PC does not recognize the receiver, disconnect the USB cable and connect it again. If this does not work, restart Windows.
- The drivers installed can be recognized only when the USB cable is connected between the receiver and your PC.
- The sound may not be played back correctly — interrupted or degraded — due to your PC settings and PC specifications.

* Microsoft®, Windows® 98, Windows® Me and Windows® 2000 are registered trademarks of Microsoft corporation.

Setting Up the RF Rod Antenna

The remote control supplied for this receiver can transmit RF (Radio Frequency) signal. The RF rod antenna can receive the RF signals emitted from the remote control. So, with the RF rod antenna connected, you can operate the receiver at a distance of up to 50 feet (15 m) using the remote control. However, if the antenna cannot receive signals stably, you cannot operate the receiver correctly.

- The signal-reachable distance may differ depending on the operating conditions and circumstances. To improve transmitting conditions, change the distance to the receiver and the direction to transmit while operating the remote control.
- Without the RF rod antenna connected, you can operate the receiver with the remote control, aiming the remote control directly toward the remote sensor on the receiver.

To set up the RF rod antenna

1. Insert the RF rod antenna to the RF REMOTE ANTENNA terminal.

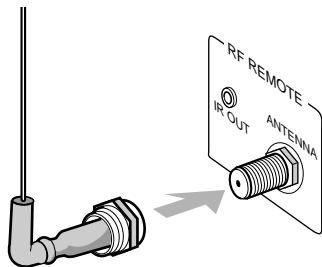

2. Rotate the fixing nut to attach the RF rod antenna firmly.

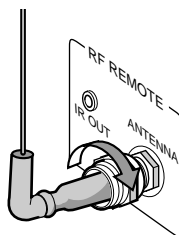

The RF rod antenna and IR signal Transmitter

The combination of the RF rod antenna and the IR signal transmitter (see to the right) allows you to use the Multi-room function more conveniently.

The remote control supplied for this receiver can transmit both RF (Radio Frequency) signal and IR (infrared) signal at the same time. This receiver catches the RF signals emitted from the remote control, and converts them into IR signals, then transmits the converted signals to the remote sensor on the other components through IR signal transmitter.

This means that you can control not only this receiver but the other components from the sub-room.

Note:

To avoid a failure in the reception from the remote control, keep the connecting cables and the IR signal transmitter's cable away from the RF rod antenna.

Setting Up the IR Signal Transmitter

The IR signal transmitter can transmit the IR signals.

It allows you to use the AV COMPULINK system, and to operate other manufacturers' components without aiming the remote control directly toward the remote sensor on the target components. In addition, the IR signal transmitter reduces the possibility of malfunction.

- The IR signal transmitter may not operate the target components depending on the operating conditions and circumstances — including the aiming angle and direction of the IR signal transmitter toward the remote sensors of the target components. If this occurs, changing its aiming angle and direction toward the remote sensors may solve the problem.

To set up the IR signal transmitter

1. Find the place where you attach the IR signal transmitter.

- Place it where the signal can reach the remote sensor of the target components directly (in the line-of-sight).
- If the cord length of the IR signal transmitter is not long enough, use an extension cord (not supplied).

2. Attach the double-sided adhesive tape (supplied) to the IR signal transmitter.

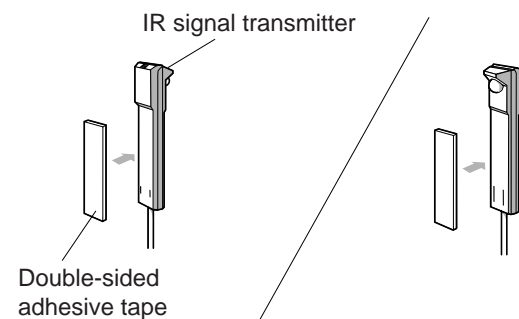

3. Connect the plug of the transmitter to the IR OUT jack of the receiver and place the transmitter.

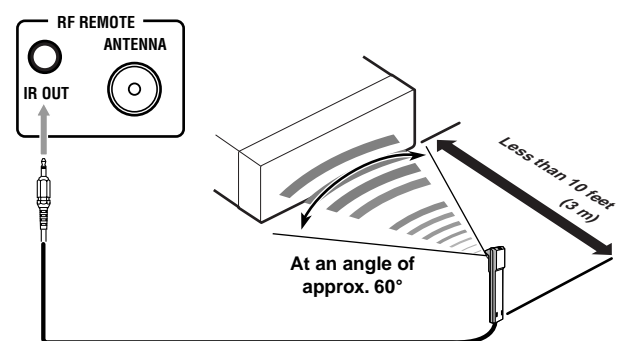

Signal-emitting angle of the transmitter

Horizontally: 60°

Vertically: 60°

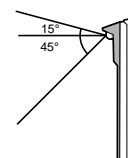
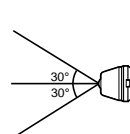

Connecting the Power Cord

Before plugging the receiver into an AC outlet, make sure that all connections have been made.

Plug the power cord into an AC outlet.

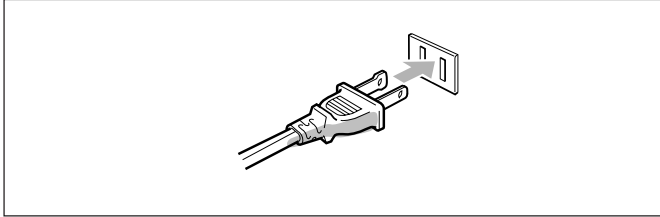

Keep the power cord away from the connecting cables and the antenna. The power cord may cause noise or screen interference. We recommend that you use a coaxial cable to connect the antenna, since it is well-shielded against interference.

Note:

The preset settings such as preset channels and sound adjustment may be erased in a few days in the following cases:

- When you unplug the power cord.
- When a power failure occurs.

CAUTIONS:

- Do not touch the power cord with wet hands.
 - Do not pull on the power cord to unplug the cord. When unplugging the cord, always grasp the plug so as not to damage the cord.
-

Putting Batteries in the Remote Control

Before using the remote control, put two supplied batteries first.

1. On the back of the remote control, remove the battery cover.

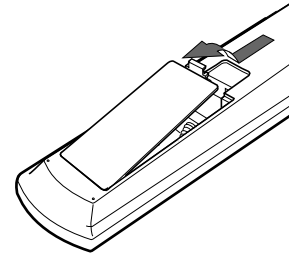

2. Insert batteries. Make sure to match the polarity: (+) to (+).

R6P(SUM3)/AA(15F)

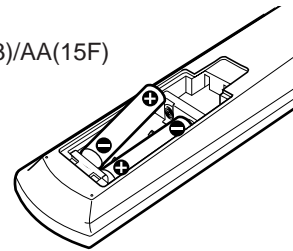

3. Replace the cover.

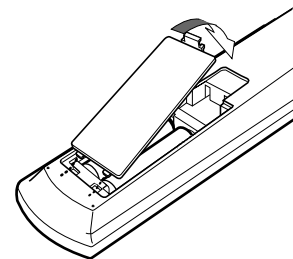

If the remote control cannot transmit signals and operate the receiver correctly, replace the batteries. Use two R6P(SUM3)/AA(15F) type dry-cell batteries.

Notes:

- When you can aim the remote control directly at the remote sensor on the receiver, you can operate the receiver at a distance of up to 23 feet (7 m).
- After replacing the batteries, set the manufacturers' codes again (see page 68).

CAUTIONS:

Follow these precautions to avoid leaking or cracking cells:

- Place batteries in the remote control so they match the polarity: (+) to (+) and (–) to (–).
 - Use the correct type of batteries. Batteries that look similar may differ in voltage.
 - Always replace both batteries at the same time.
 - Do not expose batteries to heat or flame.
-

Multi-room Operations

Before operating this receiver any further, be familiar with this Multi-room function.

This function enables you to listen to different sources in two different places (we call these two places "main room" and "sub-room") by using this receiver only.

This section explains only required speaker connections, the concept, and basic operations of the Multi-room function. For more detailed operations, see the respective pages in this manual.

Required Speaker Connections for the Sub-room

Connection A

See also "Connecting the front speakers" on page 6.

Right speaker — MAIN ROOM SPEAKERS — Left speaker

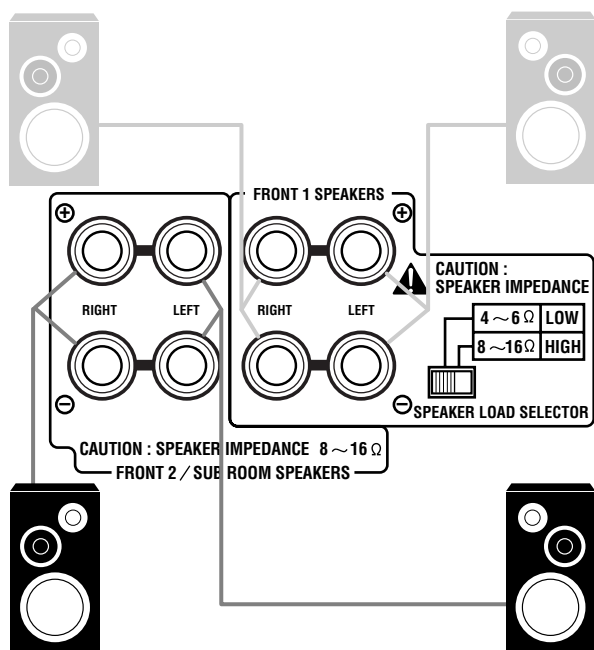

Right speaker — SUB ROOM SPEAKERS — Left speaker

Merits:

- This connection DOES NOT require a power amplifier.

Demerits:

- When the sub-room speakers are activated, this connection DOES NOT allow you to use the Surround/DSP modes using the center/rear speakers (see page 37) and the DVD MULTI playback mode (see page 49) for the main room sources.

To use the front speakers connected to the FRONT 2/SUB ROOM SPEAKERS terminals for the sub-room

See "Setting the Front Speakers Either for the Main Room or Sub-room" on page 27, and "Activating the Sub-room Front Speakers" on page 26.

Note:

Using long speaker signal cables will deteriorate the signals, and will result in poor sound quality.

Connection B

Connect the input jacks of another amplifier to the SUB ROOM PRE OUT jacks on the rear panel, using a cable with RCA pin plugs (not supplied).

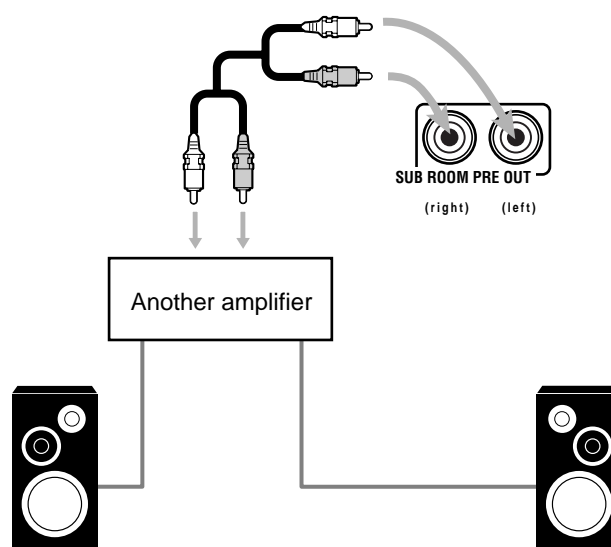

Right speaker — SUB ROOM SPEAKERS — Left speaker

Merits:

- This connection DOES allow you to use the Surround/DSP mode using the center/rear speakers (see page 37) and the DVD MULTI playback mode (see page 49) for the main room sources.

Demerits:

- This connection DOES require another amplifier.

To use the front speakers in the sub-room

- No settings are required on this receiver.
- Turn on and operate the other amplifier connected to the SUB ROOM PRE OUT jacks correctly.

Note:

Using long cables will deteriorate the signals, and will result in poor sound quality.

Basic Operating Procedure for Main Room

On the front panel:

1. Press POWER.

The STANDBY lamp on the front panel goes off, and the MAIN ROOM indicator lights on the display.

- For more details, “Turning the Power On and Off (Standby)” on page 17.

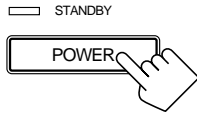

The sound comes out of the speakers in the main room, and the buttons and controls on the front panel work for the main room operations.

2. If no sounds come out of the front speakers, press SPEAKERS ON/OFF 1 and/or SPEAKERS ON/OFF 2 which you want to use.

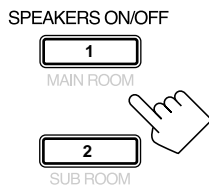

The selected indicator(s) light(s) on the display.

- For more details, see “Activating the Main Room Front Speakers” on page 19.

3. Select and play a source.

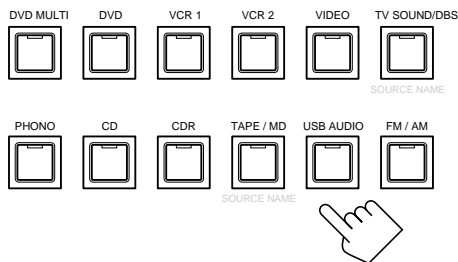

4. Turn MASTER VOLUME to adjust the volume level of the sound from the speakers in the main room.

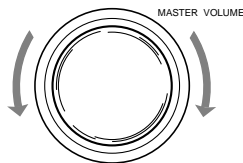

From the remote control:

1. Set MAIN ROOM/SUB ROOM selector to “MAIN ROOM.”

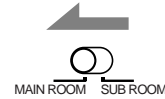

Now the buttons and controls on the remote control work for the main room operations.

2. Press AUDIO POWER ON.

The STANDBY lamp on the front panel goes off, and the MAIN ROOM indicator lights on the display.

- See also “Turning the Power On and Off (Standby)” on page 17.



The sound comes out of the speakers in the main room.

- If no sounds come out of the front speakers, press SPEAKERS ON/OFF 1 and/or SPEAKERS ON/OFF 2 on the front panel. The SPEAKERS 1 and/or 2 indicator(s) light(s) on the display.

For more details, see “Activating the Main Room Front Speakers” on page 19.

3. Select and play a source.

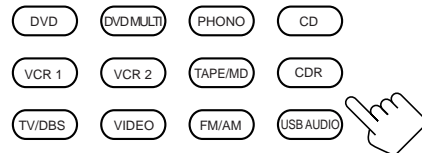

4. Press VOLUME +/- to adjust the volume level of the sound from the speakers in the main room.

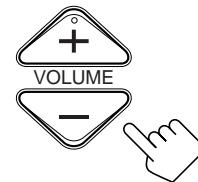

Basic Operating Procedure for Sub-Room

The sources and functions available for the sub-room operations are limited.

For more details on the sub-room operations, see “Sub-Room Operations” on pages 23 to 26.

On the front panel:

1. Press POWER.

The STANDBY lamp on the front panel goes off, and the MAIN ROOM indicator lights on the display.

- For more details, see “Turning the Power On and Off (Standby) and Selecting the Sub-room Operations” on page 23.

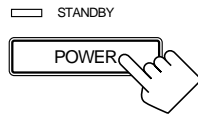

The sound comes out of the speakers in the main room, and the buttons and controls on the front panel work for the main room operations.

2. Press SUB ROOM ON/OFF so that the SUB ROOM indicator lights on the display.

The sound comes out of the front speakers in the sub-room. If no sounds come out of the front speakers, press SPEAKERS ON/OFF SUB ROOM so that the SPEAKERS SUB ROOM indicator lights on the display.

- See also “Setting the Front Speakers Either for the Main Room or Sub-room” on page 27, and “Activating the Sub-room Front Speakers” on page 26.



Note:

If the center speaker or rear speakers are used for the Surround/DSP modes (see page 37) for the main room operations, the SPEAKERS ON/OFF SUB ROOM button does not work.

3. Press SUB ROOM CONTROL so that “SUB” and the previously selected source name for the sub-room appear on the display.

Now the buttons and controls on the front panel work for the sub-room operations.



4. Select and play a source.

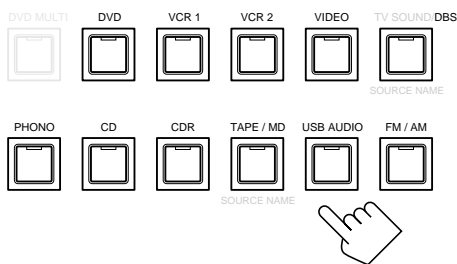

Notes:

- You cannot select DVD MULTI as a source for the sub-room.
- When the source name of TV SOUND/DBS is assigned to “TV SOUND,” TV SOUND/DBS buttons does not work. To change the source name, see “Changing the Source Name” on page 33.

5. Turn MASTER VOLUME to adjust the volume level of the sound from the front speakers in the sub-room.

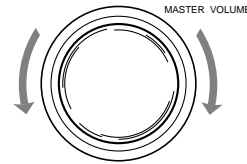

From the remote control:

1. Set MAIN ROOM/SUB ROOM selector to “SUB ROOM.”

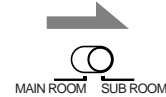

Now the buttons and controls on the remote control work for the sub-room operations.

2. Press AUDIO POWER ON.

The STANDBY lamp on the front panel goes off, and the SUB ROOM indicator lights on the display.

- See also “Turning the Power On and Off (Standby) and Selecting the Sub-room Operations” on page 23.



The sound comes out of the front speakers in the sub-room. If no sounds come out of the front speakers, press SPEAKERS ON/OFF SUB ROOM on the front panel so that the SPEAKERS SUB ROOM indicator lights on the display.

- See also “Activating the Sub-room Front Speakers” on page 26.

Note:

If the center speaker or rear speakers are used for the Surround/DSP mode (see page 37) for the main room operations, the SPEAKERS ON/OFF SUB ROOM button does not work.

3. Select and play a source.

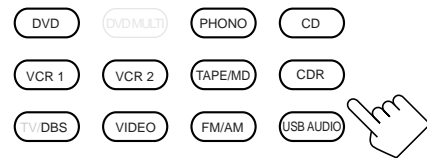

Notes:

- You cannot select DVD MULTI as a source for the sub-room.
- When the source name of TV SOUND/DBS is assigned to “TV SOUND,” TV SOUND/DBS buttons does not work. To change the source name, see “Changing the Source Name” on page 33.
- See also “Operating the Playback Source for the Sub-room” on page 26.

4. Press VOLUME +/- to adjust the volume level of the sound from the front speakers in the sub-room.

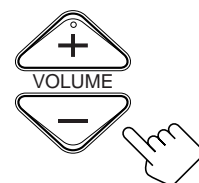

Main Room Basic Operations

This section explains only the operations commonly used when you play any sound source in the main room. See pages 23 for the sub-room operations. You can use "On-screen Menu" for most of the main room operations. For details, see page 50.

IMPORTANT:

Check to see if the proper indicator(s) and information appear on the display on the front panel before/while using the buttons and controls.

For the main room operations:

- The MAIN ROOM indicator is lit.
- The source name for the sub-room is not lit on the display.

When using the remote control:

- Set MAIN ROOM/SUB ROOM selector to "MAIN ROOM."
- Check to see if the following informations appear on the display window on the remote control:

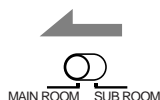

MAIN ROOM/ SUB ROOM selector	Indications
MAIN ROOM	MAIN ROOM *
SUB ROOM	SUB ROOM *

Buttons	Indications
FM/AM	TUNER
CD	CD
PHONO	PHONO
TAPE/MD	TAPE
DVD or DVD MULTI	DVD
CDR	CDR
USB AUDIO	USB
TV/DBS	TV**
VCR 1	VCR 1
VCR 2	VCR 2
VIDEO	VIDEO
SOUND	SOUND

After pressing SOUND:

DIGITAL EQ	EQ
------------	----

Ex. When you press CD with MAIN ROOM/SUB ROOM selector set to "MAIN ROOM."

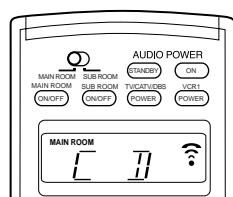

When you set MAIN ROOM/SUB ROOM selector* and press the buttons listed above, the corresponding indication appears for 10 seconds for your confirmation.

Notes:

- * MAIN ROOM or SUB ROOM indicator does not appear when no indicators appear on the display window.
- ** When you set TV/CATV/DBS selector to "CATV/DBS," "CATV" appears as the indication. (See page 68.)

Turning the Power On and Off (Standby)

On the front panel:

To turn on the power, press POWER.

The STANDBY lamp on the front panel goes off, and the MAIN ROOM indicator lights up on the display. The name of the current main room source and Surround/DSP mode appear on the display.

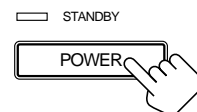

Current source name and Surround/DSP modes for the main room appear

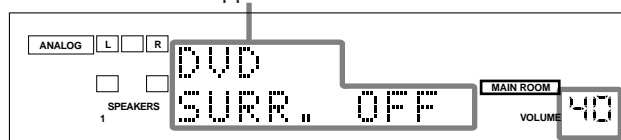

Current volume level for the main room is shown here

The currently selected SPEAKERS 1 and/or 2 indicator(s) also light up on the display.

- If the SPEAKERS 1 and/or 2 indicator(s) are not lit on the display, see "Activating the Main Room Front Speakers" on page 19.

To turn off the power (into standby mode), press POWER again.

The STANDBY lamp lights up. A small amount of power is consumed in standby mode. To turn the power off completely, unplug the AC power cord.

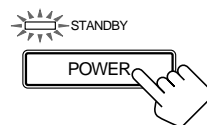

From the remote control:

To turn on the power, press AUDIO POWER ON.

The STANDBY lamp on the front panel goes off, and the MAIN ROOM indicator lights up on the display. The name of the current main room source and Surround/DSP mode appear on the display.

The currently selected SPEAKERS 1 and/or 2 indicator(s) also light up on the display.

- If the SPEAKERS 1 and/or 2 indicator(s) are not lit on the display, see "Activating the Main Room Front Speakers" on page 19.

To turn off the power (into standby mode), press AUDIO POWER STANDBY.

The STANDBY lamp lights red.*



Notes:

- When you turn off the receiver in the main room, make sure if other people are listening to any source in the sub-room (the SUB ROOM and SPEAKERS SUB ROOM indicators are lit on the display).
- If you have turned off the receiver with the volume level set at more than level "40," the volume level will be automatically set at level "40" next time you turn on the receiver.
- If "TURN ON MAIN OR SUB ROOM" appears on the display, press MAIN ROOM ON/OFF or SUB ROOM ON/OFF to listen to the sound in the main room or in the sub-room; otherwise, the receiver will turn off after about 1 minute. In this case, the receiver is turned on with the main room operations activated by pressing POWER (AUDIO POWER ON on the remote control).

Canceling the Main Room Operations

To stop the main room operations and sounds from the main room speakers, press MAIN ROOM ON/OFF.



On the front panel



From the remote control

The MAIN ROOM indicator on the display goes off, and the currently selected front speaker indicators also goes off (no sound will be heard in the main room).

- You cannot use this receiver for the main room operations any more.

To use this receiver for the main room operations again, press MAIN ROOM ON/OFF again.

The MAIN ROOM indicator lights on the display, and the front speaker indicators previously selected also light.

Now the buttons and controls on the front panel work for the main room operations.

Notes:

- If you have turned off the receiver with the volume level set at more than level "40," the volume level will be automatically set at level "40" next time you turn on the receiver.
- If "TURN ON MAIN OR SUB ROOM" appears on the display, press MAIN ROOM ON/OFF or SUB ROOM ON/OFF to listen to the sound in the main room or in the sub-room; otherwise, the receiver will turn off after about 1 minute.

Selecting the Main Room Source to Play

Press one of the source selecting buttons.

The lamp on the front panel button for selected source lights up.

- The selected source name and Surround/DSP mode also appear on the display.

On the front panel:

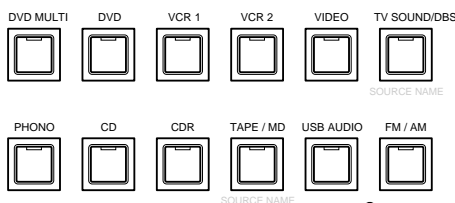

From the remote control:

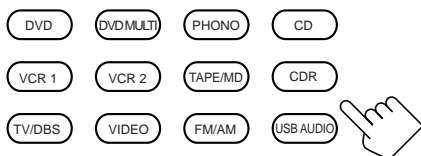

Selected source name and current Surround/DSP mode appear

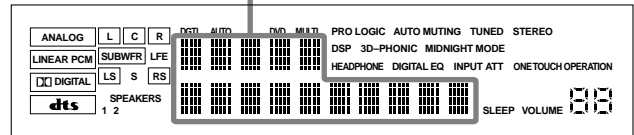

DVD
DVD MULTI

Select the DVD player.

Select the DVD player for viewing the digital video disc using the analog discrete output mode (5.1CH reproduction).

To enjoy the DVD MULTI playback, see page 49.

CD*

Select the CD player.

TAPE/MD*

Select the cassette deck (or the MD recorder).

TV (SOUND)/DBS

Select TV sounds (or the DBS tuner).

VIDEO

Select video component connected to the VIDEO jacks.

PHONO*

Select the turntable.

FM/AM*

Select an FM or AM broadcast.

- Each time you press the button, the band alternates between FM and AM.

VCR 1

Select the video component connected to the VCR 1 jacks.

VCR 2

Select the video component connected to the VCR 2 jacks.

CDR*

Select the CD recorder.

USB AUDIO*

Select the personal computer (PC) connected to the USB terminal.

Notes:

- When connecting an MD recorder (to the TAPE/MD jacks), and a DBS tuner (to the TV SOUND/DBS jacks), change the source names shown on the display. For details, see page 33.
- When you press one of the source selecting buttons on the remote control marked with an asterisk (*), the receiver automatically turns on.

Selecting different sources for picture and sound

You can watch picture from a video component while listening to sound from another component.

Press one of the audio source selecting buttons — PHONO, CD, CDR, TAPE/MD, USB(AUDIO), FM/AM — while viewing the picture from a video component such as the VCR or DVD player, etc.

The lamp on the front panel button for selected source lights up.

On the front panel:

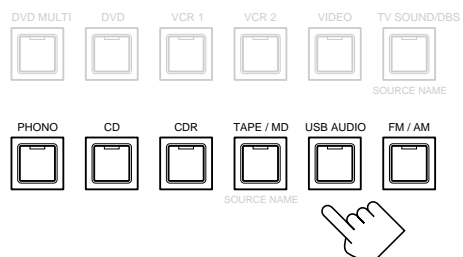

Continued to the next page.

From the remote control:

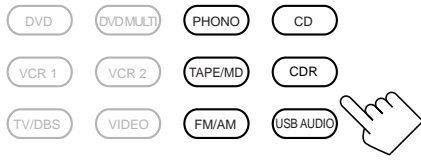

Note:

Once you have selected a video source, pictures of the selected source are sent to the TV until you select another video source.

Speaker and signal indicators on the display

By checking the following indicators, you can easily confirm which speakers you are activating and which signals are coming into this receiver from the source.

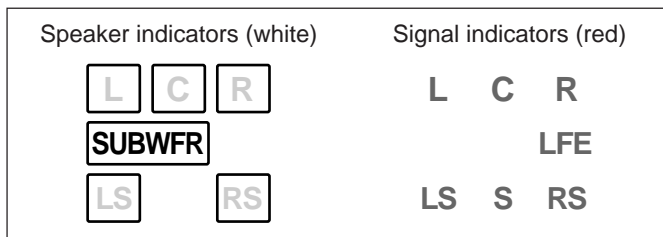

The speaker indicators

The indicators correspond to the speakers as follows:

Frame	Speaker	
L	Left front	It always lights while the main room is activated.
R	Right front	
C	Center	It lights when you set the corresponding speaker correctly. (For details, see page 29.)
LS	Left rear	
RS	Right rear	
SUBWFR	Subwoofer	It always lights when "SUBWOOFER" is set to "YES."* (For details, see page 28.)

The signal indicators

The signal indicators light in the following cases:

- When the DIGITAL input mode (see page 31) is selected, only the indicators for the incoming signals light.
- When the ANALOG input mode (see page 31) is selected, the indicators light as follows:
 - When selecting "DVD MULTI" (see pages 9 and 49), all the signal indicators except "S" always light on the display.
 - When selecting the sources other than "DVD MULTI," only "L" and "R" always light on the display.

To bring out the best performance of this receiver, check the speaker and signal indicators on the display carefully and set the speakers correctly.

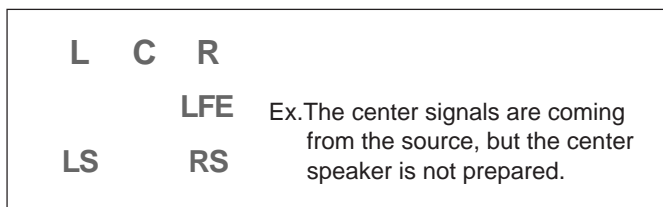

Notes:

- "S" is the monaural rear signal. It is automatically mixed down to "LS" and "RS."
- "LFE" signals are automatically mixed down to the other signals when you select the digital input mode. However, when you select "DVD MULTI," this receiver reproduces the LFE signals only through subwoofer channel.
- * When you do not press SUBWOOFER OUT ON/OFF to deactivate the subwoofer.

Adjusting the Main Room Volume

On the front panel:

To increase the volume, turn MASTER VOLUME clockwise.

To decrease the volume, turn it counterclockwise.

- When you turn MASTER VOLUME rapidly, the volume level also changes rapidly.
- When you turn MASTER VOLUME slowly, the volume level also changes slowly.

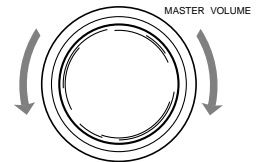

From the remote control:

To increase the volume, press VOLUME +.

To decrease the volume, press VOLUME -.



CAUTIONS:

- Always set the volume to the minimum before starting any source. If the volume is set at its high level, the sudden blast of sound energy can permanently damage your hearing and/or ruin your speakers.
- Be careful not to turn up the volume so high when controlling the receiver without listening to the playback sound. For example, when adjusting the volume level in the sub-room from the main room.

Notes:

- The volume level can be adjusted within the range of "0" (minimum) to "90" (maximum).
- If you set One Touch Operation to "ON" (see page 34), you do not have to adjust the volume level each time you change the source. It is automatically set to the stored level for the previous setting.

Activating the Main Room Front Speakers

When shipped from the factory, both pairs of the front speakers have been set to be used in the main room.

- To use the front speakers connected to the FRONT 2/SUB ROOM SPEAKERS terminals for the sub-room, see "Setting the Front Speakers Either for the Main Room or Sub-room" on page 27, and "Activating the Sub-room Front Speakers" on page 26.

IMPORTANT:

You can activate two pairs of the front speakers at the same time only when the SPEAKER LOAD SELECTOR switch on the rear panel is set to the "HIGH" position and when no signals are sent to the center and rear speakers. Otherwise, activating one pair of the speakers deactivates the other.

On the front panel ONLY:

When you have connected two pairs of the front speakers and set them to the main room, you can select which to use in the main room.

To use the speakers connected to the FRONT 1 SPEAKERS terminals, press SPEAKERS ON/OFF 1 so that SPEAKERS 1 indicator lights up on the display. (Make sure that the SPEAKERS 2 is not on the display.)

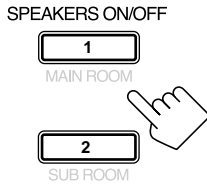

To use the speakers connected to the FRONT 2/SUB ROOM SPEAKERS terminals, press SPEAKERS ON/OFF 2 so that SPEAKERS 2 indicator lights up on the display. (Make sure that the SPEAKERS 1 is not on the display.)

To use both sets of the speakers, press SPEAKERS ON/OFF 1 and SPEAKERS ON/OFF 2 so that the SPEAKERS 1 and SPEAKERS 2 indicators light up on the display.

To use neither sets of the speakers, press SPEAKERS ON/OFF 1 and SPEAKERS ON/OFF 2 so that the SPEAKERS 1 and SPEAKERS 2 indicators disappear from the display. The HEADPHONE indicator lights up and "HEADPHONE"* appears on the display.

- Activating the speaker turns on the Surround and DSP modes previously selected.
- **Listening only with headphones:**
You can listen with the headphones without deactivating both pairs of speakers by connecting a pair of headphones to the PHONES jack on the front panel. If you want to use a pair of headphones without outputting sounds from the front speakers, you must turn off both pairs of the front speakers as mentioned above.

Notes:

- If you select any of the Surround/DSP modes with the center and/or rear speaker(s) or "DVD MULTI" when both front speakers are activated, the speakers connected to the FRONT 2/SUB ROOM SPEAKERS terminals are deactivated.
- * If you use a Surround with DAP mode or a DSP mode, "HEADPHONE DSP" appears on the display. You can enjoy spacious stereo effect with this mode.

CAUTION:

Be sure to turn down the volume before connecting or putting on headphones, as high volume can damage both the headphones and your hearing.

Adjusting the Equalization Patterns

You can adjust equalization patterns to your preference.

- You can do this setting for each source.

Before you start, remember....

- There is a time limit in doing the following steps. If the setting is canceled before you finish, start from step 1 again.

On the front panel:

1. Press DIGITAL EQ (Equalization) repeatedly to select the frequency.

The display changes to show the current setting.

- Each time you press the button, the frequency and its level change as follows:

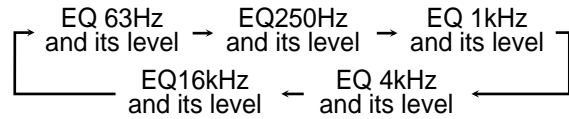

2. Press CONTROL UP ▲/DOWN ▼ repeatedly to adjust the frequency level.

The frequency level changes by 2 dB from - 8 dB to +8 dB.

The DIGITAL EQ indicator lights on the display.

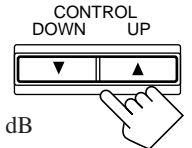

3. Repeat Steps 1 and 2 to adjust the other frequencies.

To flat the frequency patterns for digital equalization

Set all the frequency levels to "0" in step 2. The DIGITAL EQ indicator goes off from the display.

From the remote control:

1. Press SOUND.

The 10 keys are activated for sound adjustments.

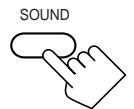

2. Press DIGITAL EQ repeatedly to select the frequency you want.

The display changes to show the current setting.

- Each time you press the button, the frequency and its level change as follows:

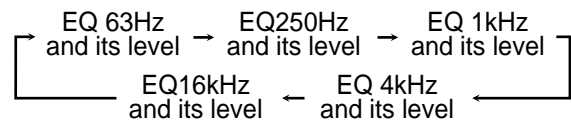

3. Press LEVEL + or LEVEL - repeatedly to adjust the frequency level.

The frequency level changes by 2 dB from - 8 dB to +8 dB.

The DIGITAL EQ indicator lights on the display.

- Each time you press the button, "EQ" appears on the display window on the remote control.

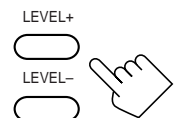

4. Repeat steps 2 and 3 to adjust the other frequencies.

To flat the frequency patterns for digital equalization

Set all the frequency levels to "0" in step 3. The DIGITAL EQ indicator goes off from the display.

Notes:

- This function is applied only to the main room sources.
- When the Line Direct function is turned on, the Digital Equalization cannot be adjusted. (See page 22.)
- The Digital Equalization affects the front speaker sounds only.

Listening at Night — Midnight Mode

Using the midnight mode, you can enjoy a powerful sound at night even at a low volume level.

- You can do this setting for each source.

Press MIDNIGHT MODE.

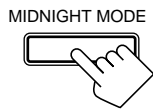

On the front panel



From the remote control

- Each time you press the button, the midnight mode changes as follows:

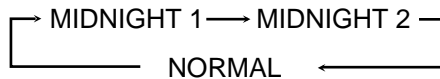

MIDNIGHT 1: Select this when you want to compress the dynamic range a little.
The MIDNIGHT MODE indicator lights on the display.

MIDNIGHT 2: Select this when you want to compress the dynamic range fully. (useful at midnight)
The MIDNIGHT MODE indicator lights on the display.

NORMAL: Select this when you want to enjoy surround with its full dynamic range. (no effect applied)
The MIDNIGHT MODE indicator goes off from the display.

Notes:

- This function is applied only to the main room sources.
- When the Line Direct function is turned on, the midnight mode is canceled. (See page 22.)
- The midnight mode is not valid for the DVD MULTI playback mode.

Activating the Subwoofer Sound

You can cancel the subwoofer sound even though you have connected a subwoofer and have set “SUBWOOFER” to “YES” (see page 28). This is useful when enjoying surround sound at night.

On the front panel ONLY:

Press **SUBWOOFER OUT ON/OFF** to cancel the subwoofer sound output.

Each time you press the button, the subwoofer sound output is deactivated (“SUBWFR OFF”) or activated (“SUBWFR ON”).

SUBWOOFER OUT ON/OFF

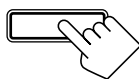

- Select “SUBWFR OFF” to deactivate the subwoofer sound output.
- Select “SUBWFR ON” to activate it.

Note:

You cannot select “SUBWFR OFF” when you have set “FRONT SPK” to “SMALL.” See page 29.

Reinforcing the Bass

You can boost the bass level.

- You can do this setting for each source.

Press BASS BOOST.

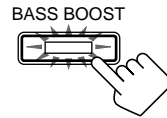

On the front panel



From the remote control

The BASS BOOST lamp on the front panel button lights up.

- Each time you press the button, the bass boost function turns on (“BOOST ON”) and off (“BOOST OFF”).
 - Select “BOOST ON” to activate the bass boost function.
The BASS BOOST lamp on the front panel button lights up.
 - Select “BOOST OFF” to cancel it.
The BASS BOOST lamp on the front panel button goes off.

Notes:

- This function is applied only to the main room sources.
- This function does not affect the sound outputting from the rear speakers.

Muting the Main Room Sound

From the remote control ONLY:

Press **MUTING** to mute the sound through all speakers in the main room and headphones connected.

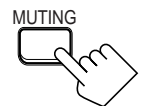

“MUTING” appears on the display and the volume turns off (the volume level indicator goes off).

To restore the sound, press MUTING again so that “MUTING OFF” appears on the display.

- Turning MASTER VOLUME on the front panel or pressing VOLUME +/- on the remote control also restores the sound.

Attenuating the Input Signal

When the input level of the playing source is too high, the sounds will be distorted. If this happens, you need to attenuate the input signal level to prevent the sound distortion.

- You can do this setting for each source.

On the front panel ONLY:

Press and hold **INPUT ATT** so that the INPUT ATT indicator lights up on the display.

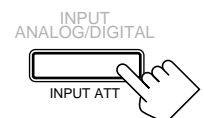

- Each time you press and hold the button, the input attenuator mode turns on (“ATT ON”) or off (“NORMAL”).

Notes:

- This effect is applied to only the main room sources connected to the analog terminals.
- This function is not valid for the DVD MULTI playback mode.

Selecting the Line Direct Function

You can enjoy the sound closer to original source by skipping the sound adjustments such as Digital Equalization and Midnight Mode. Only the volume level and Bass Boost are adjustable when the Line Direct function is turned on.

- You can do this setting for each source.

Press LINE DIRECT.

The LINE DIRECT lamp on the front panel button lights up.

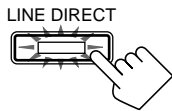

On the front panel



From the remote control

- Each time you press the button, the Line Direct function turns on (“DIRECT ON”) and off (“DIRECT OFF”).
 - Select “DIRECT ON” to activate the Line Direct function. The LINE DIRECT lamp on the front panel button lights up.
 - Select “DIRECT OFF” to cancel it. The LINE DIRECT lamp on the front panel button goes off.

Notes:

- This function is applied only to the main room sources.
- If you turn on the Line Direct function while using the Surround and DSP modes, the effect changes as follows:

Input \ Mode	Surround	DSP
Analog	Not valid	Not valid
Digital	Valid	Not valid

- Turning off the Line Direct function activates the sound adjustments previously selected such as the Digital Equalization and Midnight Mode.

Changing the Display Brightness

You can dim the display.

Press DIMMER.

- Each time you press the button, the display dims and brightens alternately.



On the front panel

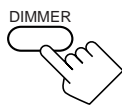

From the remote control

Note:

Even though you have made the display dimmer, it brightens for a while when you operate the receiver (except SURROUND ON/OFF, source selecting buttons, MAIN ROOM ON/OFF, SUBROOM ON/OFF, and SUB ROOM CONTROL).

Using the Sleep Timer

Using the Sleep Timer, you can fall asleep to music and know the receiver will turn off by itself rather than play all night.

From the remote control ONLY:

Press SLEEP repeatedly.

The SLEEP indicator lights up on the display, and the shut-off time changes as follows (in minutes):

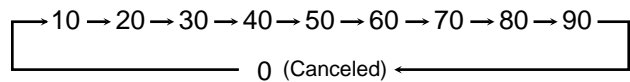

When the shut-off time comes

The receiver turns off automatically.

- If the sub-room source is still played (the SUB ROOM and SPEAKERS SUB ROOM indicators are lit on the display) when the shut-off time comes, the receiver will not turn off, but only the main room sound will shut off.

To check or change the time remaining until the shut-off time

Press SLEEP once.

The remaining time until the shut-off time appears in minutes.

- To change the shut-off time, press SLEEP repeatedly.

To cancel the Sleep Timer

Press SLEEP repeatedly until “SLEEP 0min” appears on the display. (The SLEEP indicator goes off.)

- Turning off the power also cancels the Sleep Timer.

Recording a Source

For analog-to-analog recording

You can record any analog source through the receiver to —

- the cassette deck (or MD recorder) connected to the TAPE/MD jacks,
 - the VCRs connected to the VCR 1 and VCR 2 jacks, and
 - the CD recorder connected to the CDR jacks
- at the same time.

For digital-to-digital recording

You can record the currently selected digital input source through the receiver to a digital recording device connected to the DIGITAL OUT terminal.

Notes:

- Analog-to-digital and digital-to-analog recordings are not possible.
- The output volume level, Midnight Mode (see page 21), Bass Boost (see page 21), Digital Equalization (see page 20), Surround/DSP modes (see page 37) cannot affect the recording.
- The test tone signal (see pages 40) does not come out through the DIGITAL OUT terminal.

IMPORTANT:

- While recording, do not turn off the receiver or main room source; otherwise, recording will stop.
- If the same source is selected both for the main room and the sub-room, operating the sub-room source will affect the recording.

Sub-Room Operations



This section explains only the operations used when you play any sound source in the sub-room. See pages 17 for the main room operations.

IMPORTANT:

Check to see if the proper indicator(s) and information appear on the display on the front panel before/while using the buttons and controls.

For the sub-room operations:

- The SUB ROOM indicator is lit.
- The source name for the sub-room is lit on the display.

When using the remote control:

- Set MAIN ROOM/SUB ROOM selector to “SUB ROOM.”
- Check to see if the following information appear on the display window on the remote control:

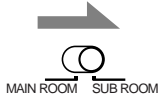

MAIN ROOM/ SUB ROOM selector	Indications
MAIN ROOM	MAIN ROOM *
SUB ROOM	SUB ROOM *

Buttons	Indications
FM/AM	TUNER
CD	CD
PHONO	PHONO
TAPE/MD	TAPE
DVD	DVD
CDR	CDR
USB AUDIO	USB
TV/DBS	TV**
VCR 1	VCR 1
VCR 2	VCR 2
VIDEO	VIDEO

Ex. When you press CD with MAIN ROOM/SUB ROOM selector set to “SUB ROOM.”

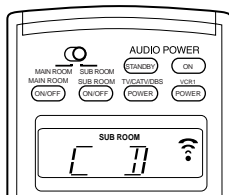

When you set MAIN ROOM/SUB ROOM selector* and press the buttons listed above, the corresponding indication appears for 10 seconds for your confirmation.

Notes:

- You can only select the analog input as the sub-room source.
- * MAIN ROOM or SUB ROOM indicator does not appear when no indicators appear on the display window.
- ** When you set TV/CATV/DBS selector to “CATV/DBS,” “CATV” appears as the indication. (See page 68.)

Turning the Power On and Off (Standby) and Selecting the Sub-room Operations

On the front panel:

1. Press POWER.

The STANDBY lamp on the front panel goes off, and the MAIN ROOM indicator lights up on the display. The name of the current main room source (or station frequency) appears on the display.

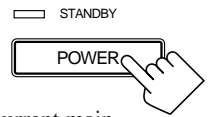

Current source name and Surround/DSP modes for the main room appear

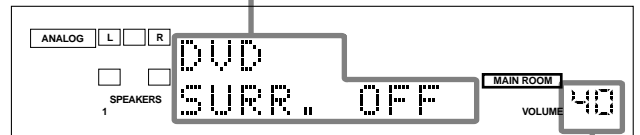

Current volume level for the main room is shown here

The currently selected SPEAKERS 1 and/or 2 indicator(s) light(s) up on the display.

2. Press SUB ROOM ON/OFF.

The SUB ROOM indicator lights up on the display (and the SPEAKERS SUB ROOM indicator lights up on the display if it has been activated).



- If the SPEAKERS SUB ROOM indicator is not lit on the display, see also “Setting the Front Speakers Either for the Main Room or Sub-room” on page 27, and “Activating the Sub-room Front Speakers” on page 26.

3. Press SUB ROOM CONTROL.

The current source name for the sub-room appears on the display.



“SUB” and the source name for the sub-room appear

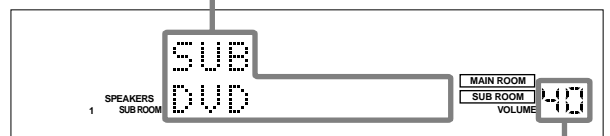

Current volume level for the sub-room is shown here

Now the buttons and controls on the front panel work for the sub-room operations.

- Each time you press the button, the buttons and controls on the front panel alternate between for the main room and for the sub-room.

To turn off the power (into standby mode), press POWER again.

The STANDBY lamp lights red. A small amount of power is consumed in standby

mode. To turn the power off completely, unplug the AC power cord.

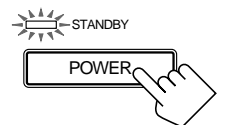

From the remote control:

1. Set MAIN ROOM/SUB ROOM selector to “SUB ROOM.”

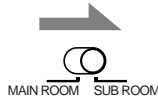

Now the buttons on the remote control work for the sub-room operations.

2. Press AUDIO POWER ON.

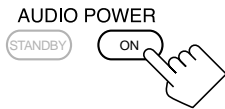

The STANDBY lamp on the front panel goes off, and the SUB ROOM indicator lights up on the display (and the SPEAKERS SUB ROOM indicator also lights up on the display if it has been activated).

- The display does not show the indication for the sub-room operations, but you can operate the sub-room.
- If the SPEAKERS SUB ROOM indicator is not lit on the display, see “Activating the Sub-room Front Speakers” on page 26.

To turn off the power (into standby mode), press AUDIO POWER STANDBY.



The STANDBY lamp lights red.

Note:

If you have turned off the receiver with the volume level set at more than level “40,” the volume level will be automatically set at level “40” next time you turn on the receiver.

Canceling the Sub-room Operations

On the front panel:

To stop the sub-room operations and sounds from the sub-room speakers, press SUB ROOM ON/OFF.



The SUB ROOM indicator on the display goes off, and the SPEAKERS SUB ROOM indicator on the display also goes off (no sound will be heard in the sub-room).

- You cannot use this receiver for the sub-room operations any more.

To use this receiver for the sub-room operations again

1. Press SUB ROOM ON/OFF.

The SUB ROOM indicator lights up on the display, and the SPEAKERS SUB ROOM indicator also lights up on the display if it has been activated.



2. Press SUB ROOM CONTROL.

The name of the current source for the sub-room appears on the display.



From the remote control:

To stop the sub-room operations and sounds from the sub-room speakers, press SUB ROOM ON/OFF.

The SUB ROOM indicator on the display goes off, and the SPEAKERS SUB ROOM indicator on the display also goes off (no sound will be heard in the sub-room).

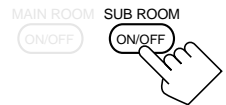

To use this receiver for the sub-room operations again, press SUB ROOM ON/OFF again.

The SUB ROOM indicator lights up on the display, and the SPEAKERS SUB ROOM indicator also lights up on the display if it has been activated.

Notes:

- If you have turned off the sub-room sound with the volume level set at more than level “40, the volume level will be automatically set at level “40” next time you turn on the sub-room sound.
- If “TURN ON MAIN OR SUB ROOM” appears on the display, press MAIN ROOM ON/OFF or SUB ROOM ON/OFF to listen to the sound in the main room or in the sub-room; otherwise, the receiver will turn off after about 1 minute.

Selecting the Sub-room Source to Play

Press one of the source selecting buttons.

The lamp on the front panel button for selected source lights up.

- The selected source name also appears on the display.
- When the source name of TV SOUND/DBS is assigned to "TV SOUND," TV SOUND/DBS buttons does not work. To change the source name, see "Changing the Source Name" on page 33.

On the front panel:

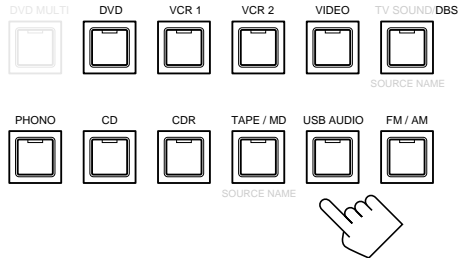

From the remote control:

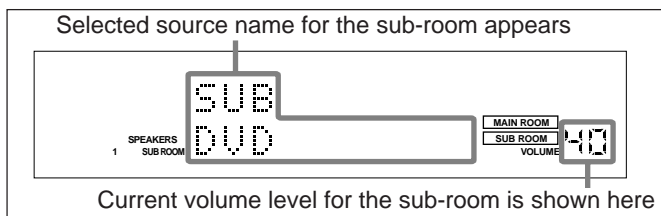
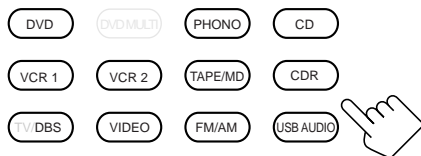

DVD	Select the DVD player.
CD*	Select the CD player.
TAPE/MD*	Select the cassette deck (or the MD recorder).
TV (SOUND)/DBS	Select DBS tuner. <ul style="list-style-type: none"> • Does not work for selecting TV.
VIDEO	Select video component connected to the VIDEO jacks.
PHONO*	Select the turntable.
FM/AM*	Select an FM or AM broadcast. <ul style="list-style-type: none"> • Each time you press the button, the band alternates between FM and AM.
VCR 1	Select the video component connected to the VCR 1 jacks.
VCR 2	Select the video component connected to the VCR 2 jacks.
CDR*	Select the CD recorder.
USB AUDIO*	Select the personal computer (PC) connected to the USB terminal.

Notes:

- When connecting an MD recorder (to the TAPE/MD jacks), and a DBS tuner (to the TV SOUND/DBS jacks), change the source names shown on the display. For details, see page 33.
- When you press one of the source selecting buttons on the remote control marked with an asterisk (*), the receiver automatically turns on. If you turn on the receiver with MAIN ROOM/SUB ROOM selector set to "SUB ROOM", press MAIN ROOM ON/OFF to activate the main room operations.
- The source lamp does not light up for the sub-room source.
- You cannot select the following as the sub-room source:
 - "TV SOUND"
 - "DVD MULTI"
 - Any digital input
 You can only select the analog input as the sub-room source.
- You can select the video components as the sub-room source; however, you can see no pictures.

Adjusting the Sub-room Volume

On the front panel:

To increase the volume, turn MASTER VOLUME clockwise.

To decrease the volume, turn it counterclockwise.

- When you turn MASTER VOLUME rapidly, the volume level also changes rapidly.
- When you turn MASTER VOLUME slowly, the volume level also changes slowly.

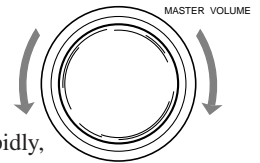

From the remote control:

To increase the volume, press VOLUME +.

To decrease the volume, press VOLUME -.



CAUTIONS:

- Always set the volume to the minimum before starting any source. If the volume is set at its high level, the sudden blast of sound energy can permanently damage your hearing and/or ruin your speakers.
- Be careful not to turn up the volume so high when controlling the receiver without listening to the playback sound. For example, when adjusting the volume level in the sub-room from the main room.

Note:

The volume level can be adjusted within the range of "0" (minimum) to "90" (maximum).

Activating the Sub-room Front Speakers

This section is not for the persons who connect the sub-room front speakers to the SUB ROOM PRE OUT jacks using another amplifier (see page 14).

Before you start, remember...

- When shipped from the factory, both pairs of the front speakers have been set to be used in the main room. To use the front speakers connected to the FRONT 2/SUB ROOM SPEAKERS terminals for the sub-room, see "Setting the Front Speakers Either for the Main Room or Sub-room" on page 27.

On the front panel ONLY:

Press SPEAKERS ON/OFF SUB ROOM to activate the front speakers in the sub-room.

The SPEAKERS SUB ROOM indicator lights up on the display.

- Each time you press the button, the lamp on the button turns on and off.

To deactivate the front speakers in the sub-room, press SPEAKERS ON/OFF SUB ROOM again.

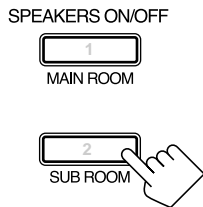

Note:

If the center speaker or rear speakers are used for the Surround/DSP mode (see page 37) for the main room operations, the SPEAKERS ON/OFF SUB ROOM button does not work.

Muting the Sub-room Sound

From the remote control ONLY:

Press MUTING to mute the sound through the front speaker in the sub-room.

The volume level indicator goes off.

To restore the sound, press MUTING again so that the volume level indicator appears on the display.

- Turning MASTER VOLUME on the front panel or pressing VOLUME +/- on the remote control also restores the sound.

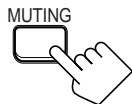

Operating the Playback Source for the Sub-room

- When you select "FM" or "AM" as the sub-room source, you can do the following:
 - Tune into any station frequency manually (see page 35).

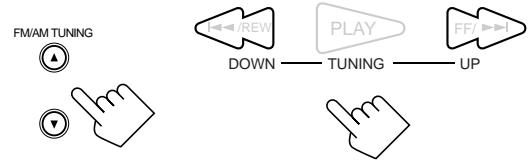

On the front panel

From the remote control

- Select a preset station (see pages 35 and 36).

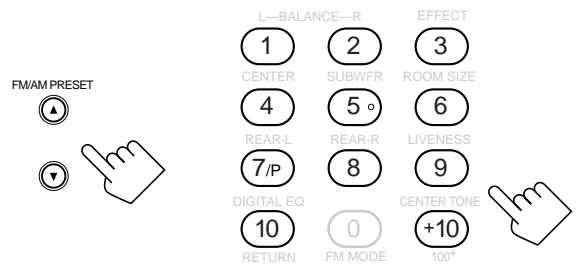

On the front panel

From the remote control

- Select FM reception mode (see page 36).



On the front panel

From the remote control

- When you select the other sources as the sub-room source, you can operate them by using the remote control supplied with this receiver. ("TV SOUND," "DVD MULTI" and the digital input cannot be selected as the sub-room source.)
 - If they are one of the JVC products equipped with the COMPU LINK remote control system or the AV COMPU LINK remote control system, see pages 55 to 64.
 - If they are one of the JVC products, but not equipped with the above remote control systems, or if they are the products of the other manufacturers, see pages 65 to 71.

CAUTION:

Be careful not to turn up the volume so high when controlling the receiver without listening to the playback sound. For example, when adjusting the volume level in the sub-room from the main room.

Notes:

- Any sound adjustments such as the Surround/DSP modes cannot be applied to the sub-room source. You can only adjust the volume level.
- The One Touch Operation function (see page 34) cannot be used for the sub-room sources.

Basic Settings

Some of the following settings are required after connecting and positioning your speakers, while others will make operations easier:

- You can use "On-screen Menu" for most of the main room operations. For details, see page 50.

The following operations are only possible while the receiver is ready for the main room operations.

IMPORTANT:

Check to see if the proper indicator(s) and information appear on the display on the front panel before/while using the buttons and controls.

For the main room operations:

- The MAIN ROOM indicator is lit.
- The source name for the sub-room is not lit on the display.

When using the remote control:

- Set MAIN ROOM/SUB ROOM selector to "MAIN ROOM."
- Check to see if the following information appear on the display window on the remote control:

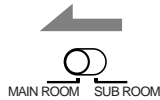

MAIN ROOM/ SUB ROOM selector	Indications
MAIN ROOM	MAIN ROOM *
SUB ROOM	SUB ROOM *

Buttons	Indications
SOUND	SOUND

After pressing SOUND, the following function are assigned to the specific number buttons:

Buttons	Indications
BALANCE L	SOUND
BALANCE R	
SUBWFR	S WFR

Ex. When you press SOUND with MAIN ROOM/SUB ROOM selector set to "MAIN ROOM."

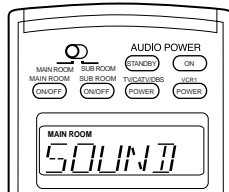

When you set MAIN ROOM/SUB ROOM selector* and press the buttons listed above, the corresponding indication appears for 10 seconds for your confirmation.

Note:

- * MAIN ROOM or SUB ROOM indicator does not appear when no indicators appear on the display window.

Setting the Front Speakers Either for the Main Room or Sub-room

You can use the front speakers connected to the FRONT 2/SUB ROOM SPEAKERS terminals either as the 2nd front speakers for the main room or as the front speakers for the sub-room.

Before you start, remember...

- There is a time limit in doing the following steps. If the setting is canceled before you finish, start from step 1 again.

On the front panel ONLY:

- Press **SETTING** repeatedly until "FRONT SPK 2:" appears on the display.

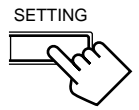

The display changes to show the current setting.

- Press **CONTROL UP ▲/DOWN ▼** to specify the way you want to use the speakers connected to the **FRONT 2/SUB ROOM SPEAKERS** terminals.

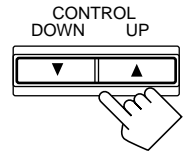

- Each time you press the buttons, the display changes to show the following:

MAIN ←→ SUB

MAIN: Select this to use as the 2nd front speakers for the main room.

SUB: Select this to use as the front speakers for the sub-room.

Note:

You can also adjust the front speakers setting with "On-screen Menus" by using remote control. (See page 54.)

Adjusting the Front Speaker Output Balance

If the sounds you hear from the front right and left speakers are unequal, you can adjust the speaker output balance.

- You can do this setting for each source.

Before you start, remember...

- There is a time limit in doing the following steps. If the setting is canceled before you finish, start from step 1 again.

On the front panel:

- Press **LEVEL ADJUST** repeatedly until "BAL - (with current setting)" appears on the display.



- Press **CONTROL UP ▲/DOWN ▼** to adjust the balance.

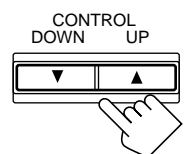

- Pressing CONTROL UP ▲ decreases the left channel output (from R -21 to CENTER, from CENTER to L -21).

- Pressing CONTROL DOWN ▼ decreases the right channel output (from L -21 to CENTER, from CENTER to R -21).

From the remote control:

1. Press SOUND.

The 10 keys are activated for sound adjustments.

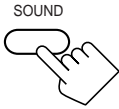

2. Press BALANCE R or BALANCE L to adjust the balance.

- Pressing BALANCE R decreases the left channel output (from R -21 to CENTER, from CENTER to L -21).
- Pressing BALANCE L decreases the right channel output (from L -21 to CENTER, from CENTER to R -21).

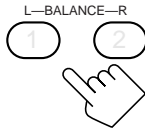

Note:

This function is applied only to the main room sources.

Setting the Subwoofer Information

Register whether you have connected a subwoofer or not.

Before you start, remember....

- There is a time limit in doing the following steps. If the setting is canceled before you finish, start from step 1 again.

On the front panel ONLY:

1. Press SETTING repeatedly until "SUBWOOFER" appears on the display.

The display changes to show the current setting.

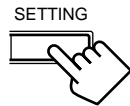

2. Press CONTROL UP ▲/DOWN ▼ to select "YES" or "NO."

- Each time you press the button, the display alternates between "YES" and "NO."

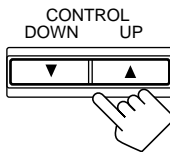

YES:	Select this when a subwoofer is connected.
NO:	Select this when no subwoofer is used.

Note:

You cannot use SUBWOOFER OUT ON/OFF on the front panel (see page 21) and adjust the subwoofer output level (see to the right) when "SUBWOOFER" is set to "NO."

Adjusting the Subwoofer Output Level

You can adjust the subwoofer output level if you have selected "YES" for the "SUBWOOFER" (see to the left).

- You can do this setting for each source.

Before you start, remember....

- There is a time limit in doing the following steps. If the setting is canceled before you finish, start from step 1 again.
- When the front speakers are all deactivated, the subwoofer level cannot be adjusted.

On the front panel:

1. Press LEVEL ADJUST repeatedly until "SUBWFR" appears on the display.

The display changes to show the current setting.



2. Press CONTROL UP ▲/DOWN ▼ to adjust the subwoofer output level (from -20 dB to +10 dB).

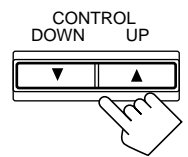

From the remote control:

1. Press SOUND.

The 10 keys are activated for sound adjustments.

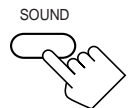

2. Press SUBWFR.



3. Press LEVEL + or LEVEL - to adjust the subwoofer output level from -20 dB to + 10 dB.

- Each time you press the button, "S WFR" appears on the display on the remote control.

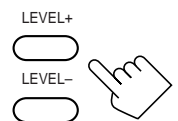

Setting the Speakers for a Surround Field

To obtain the best possible surround sound of the Surround and DSP modes, you have to register the information about the speakers arrangement after all connections are completed.

- This function is applied only to the main room sources.

Before you start, remember....

- There is a time limit in doing the following steps. If the setting is canceled before you finish, start from step 1 again.

Front, Center, and Rear Speaker Setting

Register the sizes of all the connected speakers.

- When you change your speakers, you need to register the information about the speakers again.

On the front panel ONLY:

1. Press **SETTING** repeatedly until “FRONT SPK” (Front Speaker), “CTR SPK” (Center Speaker) or “REAR SPK” (Rear Speaker) appears on the display.

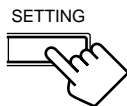

The display changes to show the current setting.

2. Press **CONTROL UP ▲ /DOWN ▼** to select the appropriate item about the speaker selected in the above step.

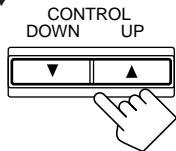

- Each time you press the button, the display changes to show the following:

→ LARGE ↔ SMALL ↔ NONE ←

LARGE: Select this when the speaker size is relatively large.

SMALL: Select this when the speaker size is relatively small.

NONE: Select this when you have not connected a speaker. (Not selectable for the front speakers)

3. Repeat steps 1 and 2 to select the appropriate items for the other speakers.

Notes:

- Keep the following comment in mind as reference when adjusting.
 - If the size of the cone speaker unit built in your speaker is greater than 4 3/4 inches (12 cm), select “LARGE,” and if it is smaller than 4 3/4 inches (12 cm), select “SMALL.”
- If you have selected “NO” for the subwoofer setting, you can only select “LARGE” for the front speaker setting.
- If you have selected “SMALL” for the front speaker setting, you cannot select “LARGE” for the center and rear speaker settings.

Center Delay Time Setting

Register the delay time of the sound from the center speaker, comparing to that of the sound from the front speakers.

If the distance from your listening point to the center speaker is equal to that to the front speakers, select 0 ms. As the distance to the center speaker becomes shorter, increase the delay time.

- 1 msec increase (or decrease) in delay time corresponds to 11 13/16 inches (30 cm) decrease (or increase) in distance.
- When shipped from the factory, the delay time is set to 0 ms.

On the front panel ONLY:

1. Press **SETTING** repeatedly until “CTR DELAY” (Center Delay) appears on the display.

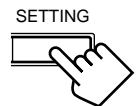

The display changes to show the current setting.

2. Press **CONTROL UP ▲ /DOWN ▼** to select the delay time of the center speaker output (from 0 ms to 5ms).

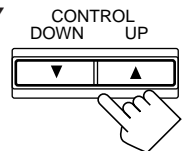

Notes:

- Center delay time is not valid for the DVD MULTI playback mode.
- You cannot adjust the center delay time when you have set “CTR SPK” to “NONE.”

Rear Delay Time Setting

Register the delay time of the sound from the rear speakers, comparing to that of the sound from the front speakers.

If the distance from your listening point to the rear speakers is equal to that to the front speakers, select 0 ms. As the distance to the rear speakers becomes shorter, increase the delay time.

- 1 msec increase (or decrease) in delay time corresponds to 11 13/16 inches (30 cm) decrease (or increase) in distance.
- When shipped from the factory, the delay time is set to 5 ms.

On the front panel ONLY:

1. Press **SETTING** repeatedly until “REAR DELAY” appears on the display.

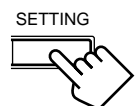

The display changes to show the current setting.

2. Press **CONTROL UP ▲ /DOWN ▼** to select the delay time of the rear speaker output (from 0 ms to 15 ms).

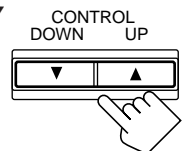

Notes:

- Rear delay time is not valid for the DVD MULTI playback mode.
- You cannot adjust the rear delay time when you have set “REAR SPK” to “NONE.”

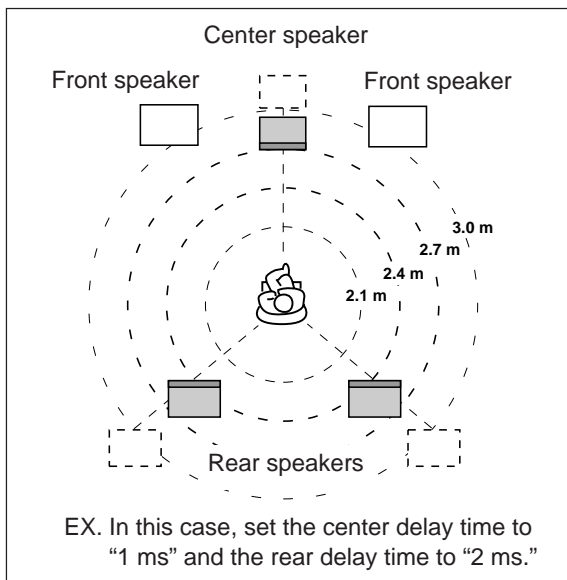

Crossover Frequency Setting

Small speakers cannot reproduce the bass sound very well. So, if you have used a small speaker for any of the front, center, and rear channels, this receiver automatically reallocate the bass elements, originally assigned to the channel for which you have connected the small speaker, to another channel (for which you have connected the large speaker).

To use this function properly, you need to set the crossover frequency level according to the size of the small speaker connected.

- If you have selected "LARGE" for all speakers (see page 29), this function cannot be adjusted.

On the front panel ONLY:

1. Press **SETTING** repeatedly until "**CROSS OVER**" appears on the display.

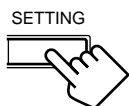

The display changes to show the current setting.

2. Press **CONTROL UP ▲/DOWN ▼** to select the crossover frequency level according to the size of the small speaker connected.

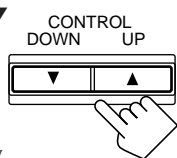

- Each time you press the button, the display changes to show the following:

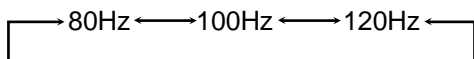

- Use the following comments as reference when adjusting:

80Hz:	Select this when the cone speaker unit built in the speaker is about 4 ³ / ₄ inches (12 cm).
100Hz:	Select this when the cone speaker unit built in the speaker is about 3 ¹⁵ / ₁₆ inches (10 cm).
120Hz:	Select this when the cone speaker unit built in the speaker is about 3 ³ / ₁₆ inches (8 cm).

Note:

Crossover frequency is not valid for the DVD MULTI playback mode, 5 CH/4 CH Stereo mode, 3D-PHONIC mode, and HEADPHONE DSP mode.

Low Frequency Effect Attenuator Setting

If the bass sound is distorted while playing back a source using Dolby Digital or DTS Digital Surround, follow the procedure below.

On the front panel ONLY:

1. Press **SETTING** repeatedly until "**LFE ATT**" (Low Frequency Effect Attenuator) appears on the display.

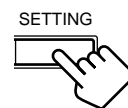

The display changes to show the current setting.

2. Press **CONTROL UP ▲/DOWN ▼** to select the low frequency effect attenuator level.

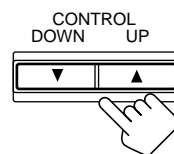

- Each time you press the button, the display changes to show the following:

0dB ←→ 10dB

0dB: Normally select this.

10dB: Select this when the bass sound is distorted.

Notes:

- Low frequency effect attenuator is not valid for the DVD MULTI playback mode.
- This function takes effect only when the Dolby Digital or DTS Digital Surround sounds with LFE signals comes in and "SUBWOOFER" is set to "YES."

Digital Input (DIGITAL IN) Terminal Setting

When you use the digital input terminals, you have to register what components are connected to which terminals (DIGITAL 1/2/3/4).

Before you start, remember...

- There is a time limit in doing the following steps. If the setting is canceled before you finish, start from step 1 again.

On the front panel ONLY:

To set the DIGITAL 1 terminal:

1. Press **SETTING** repeatedly until "**DGTL COAX**" (Digital Coaxial) appears on the display.

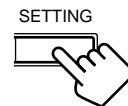

The display changes to show the current setting for DIGITAL 1 terminal.

2. Press **CONTROL UP ▲/DOWN ▼** to select the appropriate digital terminal setting.

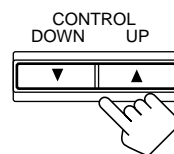

- Each time you press the button, the display changes to show the following:

1: DVD ⇄ 1: MD** ⇄ 1: CDR ⇄ 1: TV (or DBS*) ⇄ 1: CD
⇄ (back to the beginning)

* If you have changed the source name from "TV" to "DBS," "DBS" appears (see page 33).

** Change the source name to "MD" for TAPE/MD terminals when you use an MD recorder (see page 33).

Continued to the next page.

To set the DIGITAL 2/3/4 terminals:

1. Press **SETTING** until **DIGITAL 2/3/4** terminals setting appears on the display.

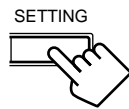

The display changes to show the current settings for the DIGITAL 2/3/4 terminals.

DIGITAL 2 terminal setting

2: CD

3: TV 4: CDR

DIGITAL 3 terminal setting

DIGITAL 4 terminal setting

2. Press **CONTROL UP ▲/DOWN ▼** to select the appropriate digital terminal settings.

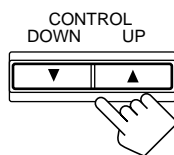

- Each time you press the buttons, the display changes to show the following:

When the DGTL COAX (DIGITAL 1) is set to "DVD"

2: CD 3: TV (or DBS*) 4: CDR ⇄ 2: CD 3: TV (or DBS*) 4: MD** ⇄
2: CD 3: MD** 4: CDR ⇄ 2: MD** 3: TV (or DBS*) 4: CDR ⇄
(back to the beginning)

*When the DGTL COAX (DIGITAL 1) is set to "MD"****

2: CD 3: TV (or DBS*) 4: CDR ⇄ 2: CD 3: TV (or DBS*) 4: DVD ⇄
2: CD 3: DVD 4: CDR ⇄ 2: DVD 3: TV (or DBS*) 4: CDR ⇄
(back to the beginning)

When the DGTL COAX (DIGITAL 1) is set to "CDR"

2: CD 3: TV (or DBS*) 4: DVD ⇄ 2: CD 3: TV (or DBS*) 4: MD** ⇄
2: CD 3: MD** 4: DVD ⇄ 2: MD** 3: TV (or DBS*) 4: DVD ⇄
(back to the beginning)

When the DGTL COAX (DIGITAL 1) is set to "TV" or "DBS"

2: CD 3: DVD 4: CDR ⇄ 2: CD 3: DVD 4: MD** ⇄
2: CD 3: MD** 4: CDR ⇄ 2: MD** 3: DVD 4: CDR ⇄
(back to the beginning)

When the DGTL COAX (DIGITAL 1) is set to "CD"

2: DVD 3: TV (or DBS*) 4: CDR ⇄ 2: DVD 3: TV (or DBS*) 4: MD** ⇄
2: DVD 3: MD** 4: CDR ⇄ 2: MD** 3: TV (or DBS*) 4: CDR ⇄
(back to the beginning)

* If you have changed the source name from "TV" to "DBS," "DBS" appears (see page 33).

** Change the source name to "MD" for TAPE/MD jacks when you use an MD recorder (see page 33).

Note:

When shipped from the factory, the DIGITAL IN terminals can be used as the digital input for the following components:

- DIGITAL 1 (coaxial): For DVD player
- DIGITAL 2 (optical): For CD player
- DIGITAL 3 (optical): For digital TV broadcast tuner
- DIGITAL 4 (optical): For CD recorder

Selecting the Analog or Digital Input Mode

When you have connected digital source components using the digital terminals (see page 10), you need to change the input mode for these components to the appropriate digital input mode correctly — DGTL AUTO, DGTL DTS, or DGTL D.D.

Before you start, remember...

- The digital input (DIGITAL IN) terminal setting should be correctly done for the sources you want to select the digital input mode for. Without setting this digital input terminal correctly, you cannot change the input mode from analog input to digital input even if you follow the procedure below.
- The digital input can be used for the main room sources. The analog input is always selected as the sub-room source without respect to this setting.

On the front panel:

1. Press one of the source selecting button (DVD, TV SOUND/DBS, CD, CDR, or TAPE/MD)* for which you want to change the input mode.

The lamp on the front panel button for selected source lights up.

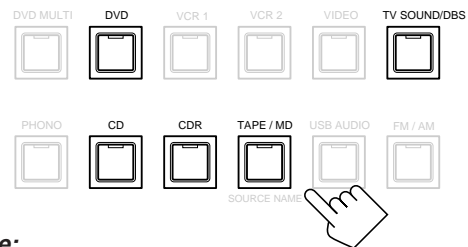

Note:

* You can select the digital input only for the sources which you have selected the digital input terminals for. (See "Digital Input (DIGITAL IN) Terminal Setting" on page 30.)

2. Press **INPUT ANALOG/DIGITAL** briefly to change the input mode.

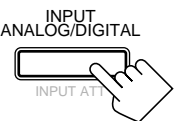

- Each time you press the button, the input mode changes as follows:

DGTL AUTO ← → ANALOG
(Digital)

DGTL AUTO: Select this for the digital input mode. The receiver automatically detects the incoming signal.

DGTL AUTO always lights up on the display, and the digital signal indicator for the detected signals also lights up.

ANALOG: Select this for the analog input mode.

ANALOG always lights up.

When selecting "DGTL AUTO", following indicators showing detected signals light up on the display.

LINEAR PCM : Lights up when Linear PCM signals come in.
• Flashes while searching the incoming signals.

LINEAR PCM : Lights up when the digital signals are not recognized.

Dolby Digital : Lights up when Dolby Digital signals come in.

dts : Lights up when DTS Digital Surround signals come in.

When playing a software encoded with the Dolby Digital or DTS Digital Surround, the following symptoms may occur:

- Sound does not come out at the beginning of playback.
- Noise comes out while using the searching for or skipping chapters or tracks.

In this case press CONTROL UP ▲/DOWN ▼ to select “DGTL D.D” or “DGTL DTS” while “DGTL AUTO” still remains on the display.

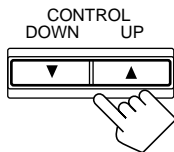

- Each time you press the button, the input mode changes as follows:



- “DGTL” lights instead of “DGTL AUTO” on the display when “DGTL D.D” or “DGTL DTS” is selected.

When selecting “DGTL D.D” or “DGTL DTS”, following indicators showing detected signals light up on the display.

DGTL : Always lights up when “DGTL D.D” or “DGTL DTS” is selected.

When selecting “DGTL D.D”

 **DIGITAL** : • Lights up when Dolby Digital signals come in.
• Flashes when Dolby Digital signals are not recognized.

When selecting “DGTL DTS”

 **dts** : • Lights up when DTS Digital Surround signals come in.
• Flashes when DTS Digital Surround signals are not recognized.

Note:

When you turn off the power or select another source, “DGTL DTS” and “DGTL D.D” settings are canceled and the digital input mode is automatically reset to “DGTL AUTO.”

To change the input mode back to analog input, select “ANALOG” in step 2.

From the remote control:

1. Press the source selecting button (DVD, CD, TAPE/MD, CDR or TV/DBS)* for which you want to change the input mode.

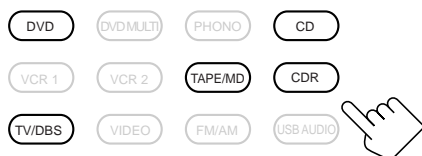

Note:

* You can select the digital input only for the sources which you have selected the digital input terminals for. (See “Digital Input (DIGITAL IN) Terminal Setting” on page 30.)

2. Press ANALOG/DIGITAL INPUT to change the input mode.



- Each time you press the button, the input mode changes as follows:

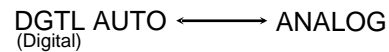

When playing a software encoded with the Dolby Digital or DTS Digital Surround, “DGTL AUTO” may not happen to work well. In this case press CONTROL UP ▲/DOWN ▼ on the front panel to select “DGTL D.D” or “DGTL DTS” (while “DGTL AUTO” remains on the display).

Note:

You can select “DGTL D.D” or “DGTL DTS” with “On-screen Menus” by using the remote control (see page 50).

Selecting the Video Input Terminal

This receiver is equipped with component video input terminals for the DVD player and DBS tuner, which give you higher picture quality. When you use the component video input terminals for the DVD player and/or DBS tuner, change the video input terminal setting.

Before you start, remember...

- There is a time limit in doing the following steps. If the setting is canceled before you finish, start from step 1 again.

On the front panel ONLY:

1. Press SETTING repeatedly until “VIDEO DVD” or “VIDEO DBS” appears on the display.

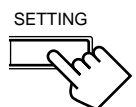

The display changes to show the current setting.

- Select “VIDEO DVD” to select the video input terminal for the DVD player and “VIDEO DBS” for the DBS tuner.

2. Press CONTROL UP ▲/DOWN ▼ to select the appropriate video input terminal.

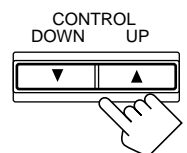

- Each time you press the button, the display changes to show the following:

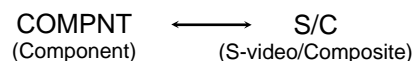

COMPNT: Select this when you connect the DVD player or DBS tuner to the component video input terminals.

S/C: Select this when you connect the DVD player or DBS tuner to the composite video or S-video input terminal.

Note:

Without changing the video input terminal setting, you can see the picture through the video input terminals, but cannot use the AV COMPU LINK remote control system correctly (see page 62).

Changing the Source Name

When you have connected an MD recorder to the TAPE/MD jacks or the DBS tuner to the TV SOUND/DBS jacks on the rear panel, change the source name which will be shown on the display when you select the MD recorder or DBS tuner as the source.

- When you select DBS as a source for the sub-room, you cannot change the source name.

On the front panel ONLY:

When changing the source name from “TAPE” to “MD”:

- Press and hold SOURCE NAME (TAPE/MD) until “ASSGN. MD” appears on the display.



When changing the source name from “TV ” to “DBS”:

- Press and hold SOURCE NAME (TV SOUND/DBS) until “ASSGN. DBS” appears on the display.

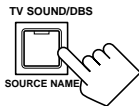

To change the source name to “TAPE” or “TV,” repeat the same procedure above — press and hold SOURCE NAME (TAPE/MD) to select “TAPE,” or press and hold SOURCE NAME (TV SOUND/DBS) to select “TV.”

Note:

Without changing the source name, you can still use the connected components. However, there may be some inconvenience.

- “TAPE” or “TV SOUND” will appear on the display when you select the MD recorder or DBS tuner.
- You cannot use the digital input (see page 30) for the MD recorder.
- You cannot use the COMPU LINK remote control system (see page 55) to operate the MD recorder.

Showing the Text Information on the Display

When you have connected an MD recorder or CD player equipped with TEXT COMPU LINK remote control system (see page 57), you can show the text information, such as disc title or track title, on the display of this receiver. To show it on the display, follow the procedure below.

Before you start, remember....

- There is a time limit in doing the following steps. If the setting is canceled before you finish, start from step 1 again.

On the front panel ONLY:

1. Press SETTING repeatedly until “FL DISP” (Display) appears on the display.

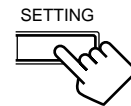

The display changes to show the current setting.

2. Press CONTROL UP ▲/DOWN ▼ to select either the source name or the text information to be shown on the display.

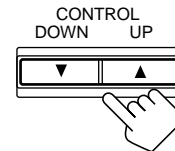

- Each time you press the button, the display changes to show the following:

NORM ←→ TEXT
(Normal)

NORM:	Source name and Surround/DSP appear during play.
TEXT:	Text information appears during play.

Note:

Though you have selected “TEXT,” the source name and Surround/DSP mode appear if a playing disc has no text information.

Basic Setting and Adjustment — Auto Memory

Without any setting required, this receiver stores different sound settings for each different playing source automatically whenever you do the following:

- Turning on the power (see page 17)
- Changing the source to play (see page 18)
- Changing the source name (see page 33)

So, you do not have to change the sound settings next time you select the same source. The stored settings for the selected source are automatically recalled.

The following settings are automatically stored for each source:

- Analog/digital input mode (see page 31)
- Bass boost (see page 21)
- Digital equalization adjustment (see page 20)
- DVD MULTI playback mode setting (see page 49)
- Front speaker output balance (see page 27)
- Input attenuator mode (see page 21)
- Line direct (see page 22)
- Midnight mode (see page 21)
- Subwoofer setting and its output level (see pages 21 and 28)
- Surround mode on/off (see page 39)
- Surround/DSP mode setting (see pages 40 – 48)

You can also assign and store the volume level for each source. See “To store the volume level” to the right.

Notes:

- This function cannot be used for the sub-room sources.
- If the source is FM or AM, you can assign different settings for each band.
- You cannot assign and store different settings for digital input mode and analog input mode (when selecting a digital source).
- The Surround modes and DSP modes cannot be used with DVD MULTI playback mode at the same time.

To store the volume level (ONE TOUCH OPERATION)

Before you start, remember...

- There is a time limit in doing the following steps. If the setting is canceled before you finish, start from step 1 again.

On the front panel ONLY:

1. Press **SETTING** repeatedly until “ONE TOUCH” appears on the display.

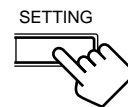

The display changes to show the current setting.

2. Press **CONTROL UP ▲/DOWN ▼** to turn on the One Touch Operation.

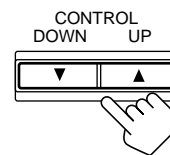

The ONE TOUCH OPERATION indicator lights up on the display.

- Each time you press the button, the one touch operation function turns on (“ON”) and off (“OFF”).

To recall the volume level

With the ONE TOUCH OPERATION indicator lit, the volume level for the currently selected source is recalled when the source is selected.

To cancel the One Touch Operation

Select “OFF” in step 2 above so that the ONE TOUCH OPERATION indicator goes off. (Even though the One Touch Operation is canceled, the recalled volume remains active.)

Receiving Radio Broadcasts

You can browse through all the stations or use the preset function to go immediately to a particular station.

- You can use "On-screen Menu" for most of the main room operations. For details, see page 50.



Indicates the functions YOU CAN ALSO USE when the receiver is ready for the sub-room operations.

IMPORTANT:

Check to see if the proper indicator(s) and information(s) appear on the display on the front panel before/while using the buttons and controls.

When using the buttons and controls on the front panel:

- For the main room operations**
 - The MAIN ROOM indicator is lit.
 - The source name for the sub-room is not lit on the display.
- For the sub-room operations**
 - The SUB ROOM indicator is lit.
 - The source name for the sub-room is lit on the display.

When using the remote control:

- For the main room operations**
 - Set MAIN ROOM/SUB ROOM selector to "MAIN ROOM."
- For the sub-room operations**
 - Set MAIN ROOM/SUB ROOM selector to "SUB ROOM."

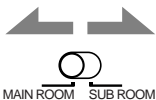

2. Press TUNING UP or TUNING DOWN until you find the frequency you want.

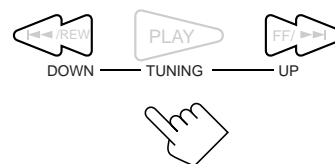

- Pressing TUNING UP increases the frequency.
- Pressing TUNING DOWN decreases the frequency.

Notes:

- When a station of sufficient signal strength is tuned in, the TUNED indicator lights on the display.
- When an FM stereo program is received, the STEREO indicator also lights up.
- When you hold the button (and release it) in step 2, the frequency keeps changing until a station is tuned in.
- You can only select the same station of the same band (FM or AM) both for the main room and sub-room operations. If you change the station for the sub-room, it also changes for the main room (and vice versa). This also means that if you change the station for the sub-room while recording a broadcasting program in the main room, recording in the main room will be interrupted.

Using Preset Tuning

Once a station is assigned to a channel number, the station can be quickly tuned. You can preset up to 30 FM and 15 AM stations.

To store the preset stations

Before you start, remember...

- There is a time limit in doing the following steps. If the setting is canceled before you finish, start from step 1 again.

On the front panel ONLY:

- Tune in the station you want to preset (see "Tuning in Stations Manually" to the left).
 - If you want to store the FM reception mode for this station, select the FM reception mode you want. See "Selecting the FM Reception Mode" on page 36.

Tuning in Stations Manually



On the front panel:

1. Press FM/AM to select the band (FM or AM).

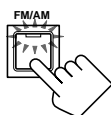

The last received station of the selected band is tuned in.

- Each time you press the button, the band alternates between FM and AM.

For the main room

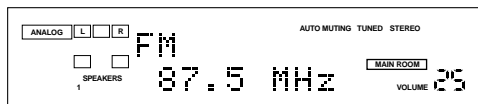

For the sub-room

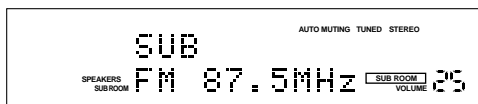

2. Press FM/AM TUNING ▲/▼ until you find the frequency you want.

- Pressing FM/AM TUNING ▲ increases the frequency.
- Pressing FM/AM TUNING ▼ decreases the frequency.

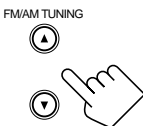

From the remote control:

1. Press FM/AM to select the band (FM or AM).



The last received station of the selected band is tuned in.

- Each time you press the button, the band alternates between FM and AM.

2. Press MEMORY.

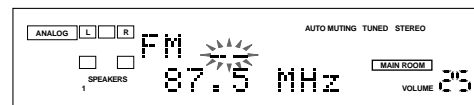

The channel number position starts flashing on the display for about 10 seconds.

3. Press FM/AM PRESET ▲/▼ to select a channel number while the channel number position is flashing.

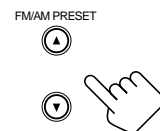

4. Press MEMORY again while the selected channel number is flashing on the display.



The selected channel number stops flashing.
The station is assigned to the selected channel number.

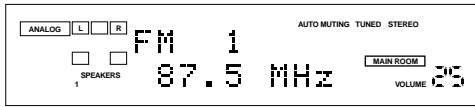

5. Repeat steps 1 to 4 until you store all the stations you want.

To erase a stored preset station

Storing a new station on a used number erases the previously stored one.

To tune in a preset station



On the front panel:

1. Press FM/AM.

The last received station of the selected band is tuned in.

- Each time you press the button, the band alternates between FM and AM.



2. Press FM/AM PRESET ▲/▼ until you find the channel you want.

- Pressing FM/AM PRESET ▲ increases the number.
- Pressing FM/AM PRESET ▼ decreases the number.



From the remote control:

1. Press FM/AM.

The last received station of the selected band is tuned in.

- Each time you press the button, the band alternates between FM and AM.



2. Press the 10 keys to select a preset channel number.

- For channel number 5, press 5.
- For channel number 15, press +10 then 5.
- For channel number 20, press +10 then 10.
- For channel number 30, press +10, +10, then 10.

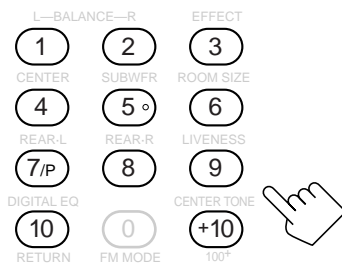

Notes:

- You can only select the same station of the same band (FM or AM) both for the main room and sub-room operations. If you change the station for the sub-room, it also changes for the main room (and vice versa). This also means that if you change the station for the sub-room while recording a broadcasting program in the main room, recording in the main room will be interrupted.
- When you use the 10 keys on the remote control, be sure that "TUNER" appears on the display window on the remote control. If not, start at step 1.
- The preset number does not appear for the sub-room.

Selecting the FM Reception Mode



When an FM stereo broadcast is hard to receive or noisy

You can change the FM reception mode while receiving an FM broadcast.

- You can store the FM reception mode for each preset station.

Press FM MODE.

- Each time you press the button, the FM reception mode alternates between "AUTOMUTING" and "MONO."



On the front panel

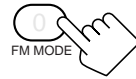

From the remote control

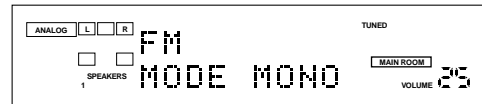
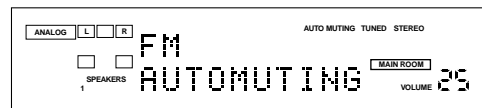

AUTOMUTING: When a program is broadcasted in stereo, you will hear stereo sound; when in monaural, you will hear monaural sound. This mode is also useful to suppress static noise between stations. The AUTO MUTING indicator lights on the display.

MONO: Reception will be improved although you will lose the stereo effect. In this mode, you will hear noise while tuning into the stations. The AUTO MUTING and STEREO indicator go off from the display.

Note:

Before you use the FM MODE button on the remote control, press FM/AM on the remote control to set the mode of the remote control to "TUNER."

Creating a Surround Field in the Main Room

The built-in Surround Processor provides Surround mode and four types of the DSP (Digital Signal Processor) mode — DAP (Digital Acoustic Processor) mode, 5 CH/4 CH Stereo mode, 3D-PHONIC mode and HEADPHONE DSP mode. With this receiver, you can use a Surround mode and a DSP mode at the same time. Once you have adjusted Surround and/or DSP modes, the adjustments done for each source are memorized.

- You can use "On-screen Menu" for most of the main room operations. For details, see page 50.

The following operations are only possible while the receiver is ready for the main room operations, and are only used for the main room sources.

Surround modes

With this receiver, you can use two types of the Surround mode. **Following modes cannot be used when only the front speakers are connected to this receiver (without the rear speakers or center speaker).**

Dolby Surround (Dolby Digital and Dolby Pro Logic)*

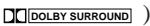
Used to watch the soundtracks of software encoded with Dolby Digital (bearing the mark ) or with Dolby Surround (bearing the mark ) .

Dolby Surround encoding format records the left front channel, right front channel, center channel, and rear channel (total 4 channels) signals into 2 channels. The Dolby Pro Logic decoder built in this receiver decode these 2 channel signals into original 4 channel signals — matrix-based multichannel reproduction, and allows you to enjoy the realistic sound field in your listening room.

On the other hand, Dolby Digital encoding method (so called a discrete 5.1 channel digital audio format) records and compresses the left front channel, right front channel, center channel, left rear channel, right rear channel, and LFE channel (total 6 channels, but LFE channel is counted as 0.1 channel, therefore called 5.1 channels) signals digitally. Each channel is completely independent from other channel signals to avoid interference, therefore, you can obtain much better sound quality with much stereo and surround effects.

The Dolby Digital decoder built in this receiver can create much more realistic sound field in your listening room. You may feel as if you were in a real theater.

In addition, Dolby Digital enables stereo rear sounds, and sets the cutoff frequency of the rear treble at 20 kHz, comparing to 7 kHz for Dolby Pro Logic. These facts enhance the sound movement and being-there feelings much more than Dolby Pro Logic.

- To enjoy the software encoded with Dolby Digital, you must connect the source component using the digital terminal on the rear of this receiver. (See page 10.)

DTS Digital Surround**

DTS Digital Surround (bearing the mark ) is another discrete 5.1 channel digital audio format available on CD, LD, and DVD software.

Comparing to Dolby Digital, audio compression rate is relatively low. This fact allows DTS Digital Surround format to add breadth and depth to the reproduced sounds. As a result, DTS Digital Surround features natural, solid and clear sound.

- To enjoy the software encoded with DTS Digital Surround, you must connect the source component using the digital terminal on the rear of this receiver. (See page 10.)

DSP modes

With this receiver, you can use four types of the DSP mode.

DAP modes

In order to reproduce a more acoustic sound field in your listening room while playing music sources, you can use DAP modes. **This mode can be used when the front speakers are connected to this receiver (without respect to the rear/center speaker connection).**

THEATER 1:	Reproduces the sound field of a large theater (where the seating capacity about 1,000).
THEATER 2:	Reproduces the sound field of a small theater (where the seating capacity about 300).
HALL 1:	Gives clear vocal and the feeling of a large concert hall (where the seating capacity about 1,000).
HALL 2:	Gives clear vocal and the feeling of a small concert hall (where the seating capacity about 300).
LIVE CLUB:	Gives the feeling of a live music club with a low ceiling.
DANCE CLUB:	Gives a throbbing bass beat.
PAVILION:	Gives the spacious feeling of a pavilion with a high ceiling.

5 CH/4 CH Stereo mode

You can create more powerful sound field for both of the digital and analog stereo sounds source. The 4 CH Stereo mode reproduces a sound field through the front left and right speakers and rear left and right speakers. The 5 CH Stereo mode adds the center channel element to the 4 CH Stereo sound field by outputting mixed left and right signals through the center speaker. **This mode cannot be used when only the front speakers are connected to this receiver without the rear speakers.**

Note:

"5CH STEREO" is selected when setting the center speaker to "LARGE" or "SMALL." "4CH STEREO" is selected when setting the center speaker to "NONE" (see page 29).

* Manufactured under license from Dolby Laboratories. "Dolby," "Pro Logic," and the double-D symbol are trademarks of Dolby Laboratories. Confidential Unpublished Works. ©1992–1997 Dolby Laboratories, Inc. All rights reserved.

** Manufactured under license from Digital Theater Systems, Inc. US Pat. No. 5,451,942 and other world-wide patents issues and pending. "DTS" and "DTS Digital Surround" are trademarks of Digital Theater Systems, Inc. ©1996 Digital Theater Systems, Inc. All rights reserved.

3D-PHONIC modes

The 3D-PHONIC mode gives you such a nearly surround effect as is reproduced through the Dolby Surround decoder, which is widely used to reproduce sounds with a feeling of movement like those experienced in movie theaters. The 3D-PHONIC mode is the result of research on sound localization technology carried out at JVC for many years. **This mode can be used when the front speakers are connected to this receiver (without respect to the rear/center speaker connection).** When the 3D PHONIC mode is reproduced with the center speaker connected, you can feel as if actors on the screen actually speak in your room.

- You can select “3D ACTION” only when playing an analog or linear PCM (digital) source.
- You can select “3D DIGITAL” only when playing a source encoded with Dolby Digital or DTS Digital Surround.

3D ACTION: Best for action and war movies — where the action is fast and explosive.

3D DIGITAL: Reproduces multichannel source encoded with Dolby Digital or with DTS Digital Surround.

HEADPHONE DSP mode

The HEADPHONE DSP mode can create the stereo sound while listening to a source using headphones as if you listen through the speakers. So you can feel as if you were in a music room. **This mode can be used only when both of the front speakers are deactivated (see page 19).**

Notes:

- When the SUB ROOM and SPEAKERS SUB ROOM indicators are lit on the display, the SURROUND ON/OFF button do not work.
- When the SUB ROOM and SPEAKERS SUB ROOM indicators are lit on the display, you can only use DAP and 3D-PHONIC modes for the main room source. In this case, “DSP” and “3D-PHONIC” indicators light up on the front panel.
- When you select “DVD MULTI” as the source to play, you cannot select or adjust the Surround and DSP modes.
- When the Line Direct function is turned on, the DSP modes are canceled temporarily (see page 22).
- No adjustment can be made for the HEADPHONE DSP mode.

Reproducing the Sound Field

The sound heard in a concert hall or club consists of direct sound and indirect sound — early reflections and reflections from behind. Direct sounds reach the listener directly without any reflection. On the other hand, indirect sounds are delayed by the distances of the ceiling and walls. These direct sounds and indirect sounds are the most important elements of the acoustic surround effects. The Surround and DSP modes can create these important elements, and give you a real “being there” feeling.

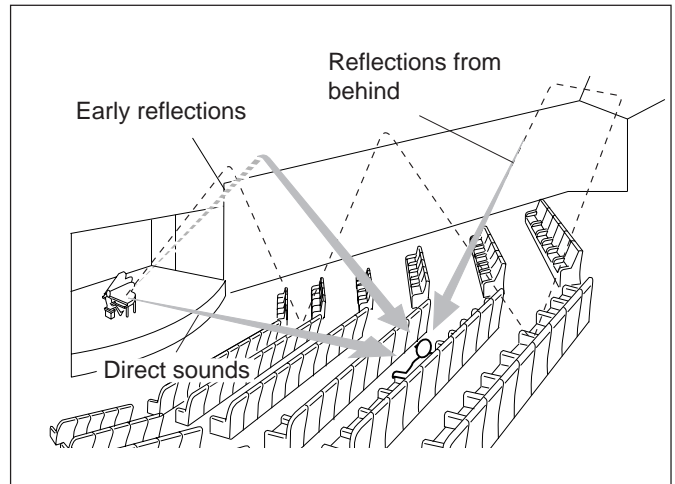

DVD MULTI Playback Mode

This receiver provides the DVD MULTI playback mode for reproducing the analog discrete 5.1 channel output mode of the DVD player or other equipment.

You can adjust the DVD MULTI playback mode while playing back a video software such as a DVD using the analog discrete 5.1 channel output mode.

- For the DVD MULTI playback mode connection, see page 9.
- For details on the DVD MULTI playback mode, see page 49.

DSP Modes Available to Input Mode

○: Possible / ×: Impossible

MODE INPUT SIGNAL	SURROUND	D S P			SURROUND with DAP	SURR. OFF (DSP OFF/ SURROUND OFF)	HEADPHOHE	
		DAP MODE	3D ACTION (DIGITAL)	5 CH/4 CH Stereo			HEADPHONE DSP	HEADPHONE
ANALOG (2 CH)	○ (DOLBY PRO LOGIC)	○	○ (3D ACTION)	○	○	○	○	○
DVD MULTI (5.1 CH)	×	×	×	×	×	×	×	○
LINEAR PCM	○ (DOLBY PRO LOGIC)	○	○ (3D ACTION)	○	○	○	○	○
DOLBY DIGITAL	○ *1 (DOLBY DIGITAL)	○	○ (3D DIGITAL)	○	○	○	○	○
DTS	○ *2 (DTS SURROUND)	○	○ (3D DIGITAL)	○	○	○	○	○

*1 When 2 channel signal comes in, DOLBY PRO LOGIC is selected. When other signals come in, DOLBY DIGITAL is selected.

*2 When 2 channel signal comes in, DOLBY PRO LOGIC is selected. When other signals come in, DTS SURROUND is selected.

Available DSP Modes According to the Speaker Arrangement

Available DSP modes will vary depending on how many speakers are used with this receiver.
Make sure that you have set the speaker information correctly (see page 29).

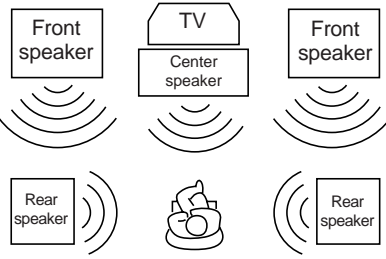
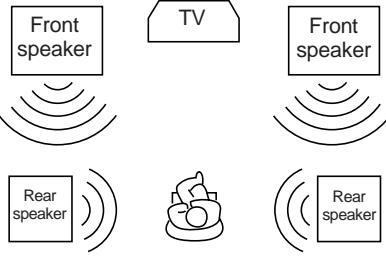
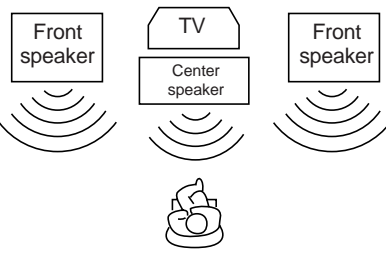
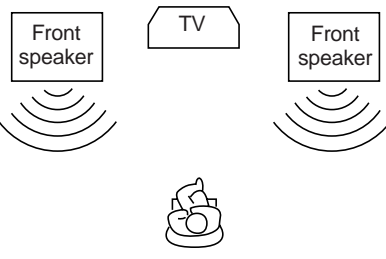
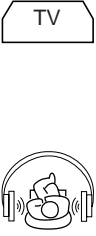
Speaker arrangements	Available DSP modes
	<p>Each time you press DSP MODE, the DSP modes change as follows:</p> <p>THEATER 1 → THEATER 2 → HALL 1 → HALL 2 → LIVE CLUB → DANCE CLUB → PAVILION → 5 CH STEREO (when using 5 speakers) or 4 CH STEREO (when using 4 speakers)* → 3D ACTION or 3D DIGITAL → SURR. OFF (DSP OFF) → (Back to the beginning)</p> <div style="border: 1px solid black; padding: 5px; margin-top: 10px;"> <p>To activate the Surround mode, press SURROUND ON/OFF button so that the SURROUND ON/OFF lamp on the front panel button lights up.</p> </div>
	<p>Notes:</p> <ul style="list-style-type: none"> • If the settings for the center and the rear speakers are changed to "NONE" (see page 29), the Surround mode will be canceled. • When both of the Surround mode and DSP mode are deactivated, "SURR. OFF" appears on the display. <p>* "5CH STEREO" is selected when setting the center speaker to "LARGE" or "SMALL," and "4CH STEREO" is selected when setting the center speaker to "NONE" (see page 29).</p>
	<p>THEATER 1 → THEATER 2 → HALL 1 → HALL 2 → LIVE CLUB → DANCE CLUB → PAVILION → 3D ACTION or 3D DIGITAL → SURR. OFF (DSP OFF) → (Back to the beginning)</p> <div style="border: 1px solid black; padding: 5px; margin-top: 10px;"> <p>To activate the Surround mode, press SURROUND ON/OFF button so that the SURROUND ON/OFF lamp on the front panel button lights up.</p> </div> <p>Notes:</p> <ul style="list-style-type: none"> • If the setting for the center speaker is changed to "NONE" (see page 29), the Surround mode will be canceled. • When both of the Surround mode and DSP mode are deactivated, "SURR. OFF" appears on the display.
	<p>THEATER 1 → THEATER 2 → HALL 1 → HALL 2 → LIVE CLUB → DANCE CLUB → PAVILION → 3D ACTION or 3D DIGITAL → SURR. OFF (DSP OFF) → (Back to the beginning)</p> <p>Note:</p> <p>Surround mode cannot be used when only the front speakers are connected.</p>
	<p>HEADPHONE ↔ HEADPHONE DSP</p> <p>Note:</p> <p>To use the HEADPHONE or HEADPHONE DSP mode, deactivate both of the front speakers (see page 19).</p>

When the SUB ROOM and SPEAKERS SUB ROOM indicators are lit on the front panel

You can only use 3D-PHONIC modes for the main room source, without respect to the center/rear speaker connection.

Adjusting the Surround Modes

Once you have adjusted the Surround modes, the adjustment is memorized for each source. You can also use a Surround mode with a DAP mode (see page 43).

IMPORTANT:

Check to see if the proper indicator(s) and information appear on the display on the front panel before/while using the buttons and controls.

For the main room operations:

- The MAIN ROOM indicator is lit.
- The source name for the sub-room is not lit on the display.
- **When using the remote control:**
 - Set MAIN ROOM/SUB ROOM selector to “MAIN ROOM.”
 - Check to see if the following information appear on the display window on the remote control.

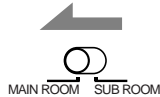

Buttons	Indications
SOUND	SOUND

After pressing SOUND, the following function are assigned to the specific number buttons:

Buttons	Indications
CENTER TONE	SOUND
CENTER	CTR
REAR•L	REARL
REAR•R	REARR

Ex. “SOUND” appears on the display window.

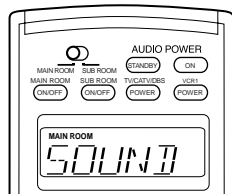

When you press the buttons listed above, the indication appears for 5 – 10 seconds for your confirmation.

Before you start, remember...

- **Make sure that you have set the speaker information correctly (see page 29).**
- When the SUB ROOM and SPEAKERS SUB ROOM indicators are lit on the display, the SURROUND ON/OFF button does not work.
- There is a time limit in doing the following steps. If the setting is canceled before you finish, start from step 3 again.
- You cannot adjust the center speaker output level and center tone when you have set “CTR SPK” to “NONE.” See page 29.
- You cannot adjust the rear speaker output levels when you have set “REAR SPK” to “NONE.” See page 29.
- To adjust the front speaker output balance and subwoofer output level, see pages 27 and 28.

From the remote control:

1. Select and play a sound source.

- To enjoy Dolby Pro Logic, play back a software encoded with Dolby Surround and labeled with mark.
- To enjoy Dolby Digital, play back a software encoded with Dolby Digital and labeled with mark.
- To enjoy DTS Digital Surround, play back a software encoded with DTS Digital Surround and labeled with mark.

2. Press SURROUND ON/OFF to activate an appropriate Surround mode — PRO LOGIC, DOLBY DIGITAL or DTS SURROUND.



The SURROUND ON/OFF lamp on the front panel button lights up.

- Each time you press the button, the Surround mode turns on and off alternately.
- When “PRO LOGIC” is selected, the PRO LOGIC indicator lights up on the display.

3. Press TEST to check the speaker output balance.

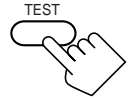

“TEST TONE L” starts flashing on the display, and a test tone comes out of the speakers in the following order:

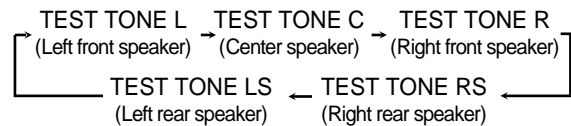

Notes:

- You can adjust the speaker output levels without outputting the test tone.
- No test tone comes out of the center speaker when “CTR SPK” is set to “NONE” (see page 29).
- No test tone comes out of the rear speakers when “REAR SPK” is set to “NONE” (see page 29).
- If the TV is turned on and the proper video input is selected on the TV, the test tone screen will appear on the TV.

4. Press SOUND.

The 10 keys are activated for sound adjustments.

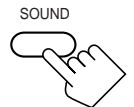

5. Select the speaker you want to adjust.

- To select the center speaker level, press CENTER.
- To select the left rear speaker level, press REAR•L.
- To select the right rear speaker level, press REAR•R.



6. Press LEVEL + or LEVEL – to adjust the speaker output levels (– 10 dB to +10 dB).

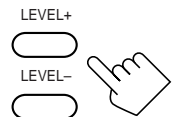

- Each time you press the button, the indication corresponding to the button selected in step 5 appears on the display window on the remote control.

7. Repeat steps 5 and 6 to adjust the other speaker output levels.

8. Press TEST again to stop the test tone.

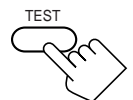

Continued to the next page.

9. Press CENTER TONE to select the center tone level you want.

The center tone adjustment affects the mid-frequency range, which the human voice is mostly made up of.

- Each time you press the button, the display changes to show the following:

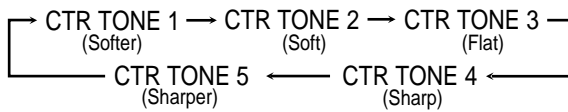

To make the dialogue softer, select “CTR TONE 1” or “CTR TONE 2.”

To make the dialogue clearer, select “CTR TONE 4” or “CTR TONE 5.”

When “CTR TONE 3” is selected, no adjustment is applied.

On the front panel:

You can also use the buttons on the front panel to adjust the Surround modes. However, no test tone is available when using the buttons on the front panel. So, make adjustments while listening to the sound of the source played back.

1. Select and play a sound source.

- To enjoy Dolby Pro Logic, play back a software encoded with Dolby Surround and labeled with mark.
- To enjoy Dolby Digital, play back a software encoded with Dolby Digital and labeled with mark.
- To enjoy DTS Digital Surround, play back a software encoded with DTS Digital Surround and labeled with mark.

2. Press SURROUND ON/OFF to activate an appropriate Surround mode — PRO LOGIC, DOLBY DIGITAL or DTS SURROUND.

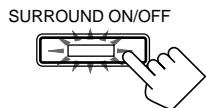

The SURROUND ON/OFF lamp on the front panel button lights up.

- Each time you press the button, the Surround mode turns on and off alternately.
- When “PRO LOGIC” is selected, the PRO LOGIC indicator lights up on the display.

3. Adjust the speaker output levels.

- 1) Press LEVEL ADJUST repeatedly until one of the following indications appears on the display.

“CENTER”:

To adjust the center speaker level.

“REAR L”:

To adjust the left rear speaker level.

“REAR R”:

To adjust the right rear speaker level.

- 2) Press CONTROL UP ▲/DOWN ▼ to adjust the selected speaker output level (from -10 dB to +10 dB).

- 3) Repeat 1) and 2) to adjust the other speaker output levels.

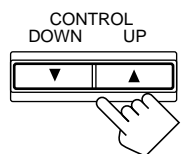

4. Adjust the center tone.

- 1) Press EFFECT repeatedly until “CTR TONE” appears on the display.

The display changes to show the current setting.

- 2) Press CONTROL UP ▲/DOWN ▼ to select the center tone level you want.

- Each time you press the button, the display changes to show the following:

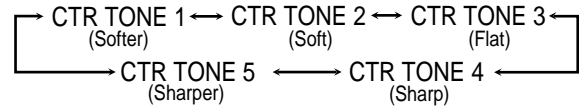

To make the dialogue softer, select “CTR TONE 1” or “CTR TONE 2.”

To make the dialogue clearer, select “CTR TONE 4” or “CTR TONE 5.”

When “CTR TONE 3” is selected, no adjustment is applied.

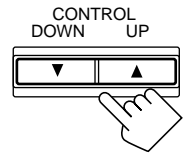
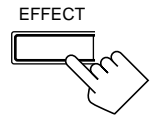

Adjusting the DAP Modes

You can also use a DAP mode with a Surround mode (see page 43).

IMPORTANT:

Check to see if the proper indicator(s) and information appear on the display on the front panel before/while using the buttons and controls.

For the main room operations:

- The MAIN ROOM indicator is lit.
- The source name for the sub-room is not lit on the display.

When using the remote control:

- Set MAIN ROOM/SUB ROOM selector to “MAIN ROOM.”
- Check to see if the following information appear on the display window on the remote control.

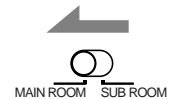

Buttons	Indications
SOUND	SOUND

After pressing SOUND, the following function are assigned to the specific number buttons:

Buttons	Indications
EFFECT	SOUND
ROOM SIZE	
LIVENESS	
CENTER TONE	
CENTER	CTR
REAR•L	REARL
REAR•R	REARR

Ex. “SOUND” appears on the display window.

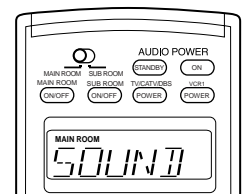

When you press the buttons listed above, the indication appears for 5 – 10 seconds for your confirmation.

Before you start, remember...

- **Make sure that you have set the speaker information correctly** (see page 29).
- When the SUB ROOM and SPEAKERS SUB ROOM indicators are lit on the display, you can only use 3D-PHONIC modes for the main room source.
- There is a time limit in doing the following steps. If the setting is canceled before you finish, start from step 2 again.
- You cannot adjust the center speaker output level when you have set “CTR SPK” to “NONE” (see page 29).
- You cannot adjust the rear speaker output level when you have set “REAR SPK” to “NONE” (see page 29).
- To adjust the front speaker output balance and subwoofer output level, see pages 27 and 28.

On the front panel:

- 1. Press DSP MODE repeatedly until the DAP mode you want to adjust — THEATER 1, THEATER 2, HALL 1, HALL 2, LIVE CLUB, DANCE CLUB, or PAVILION — appears on the display.**

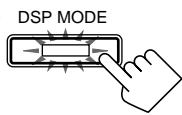

The DSP MODE lamp on the front panel button lights up, and the DSP indicator also lights up on the display.

- When you have set “REAR SPK” to “NONE,” the 3D-PHONIC indicator also lights up.

- 2. Adjust the speaker output levels.**

- 1) Press LEVEL ADJUST repeatedly until one of the following indications appears on the display.



“CENTER”:

To adjust the center speaker level.

“REAR L”:

To adjust the left rear speaker level.

“REAR R”:

To adjust the right rear speaker level.

- 2) Press CONTROL UP ▲/DOWN ▼ to adjust the selected speaker output level (from -10 dB to +10 dB).

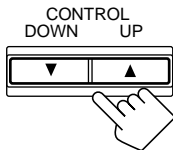

- 3) Repeat 1) and 2) to adjust the other speaker output levels.

- 3. Adjust the center tone.**

- 1) Press EFFECT repeatedly until “CTR TONE” appears on the display.

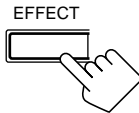

The display changes to show the current setting.

- 2) Press CONTROL UP ▲/DOWN ▼ to select the center tone level you want.

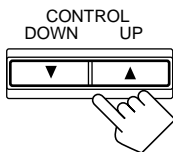

The center tone adjustment affects the mid-frequency range, which the human voice is mostly made up of.

- Each time you press the button, the display changes to show the following:

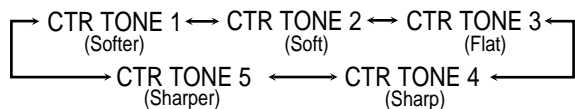

To make the dialogue softer, select “CTR TONE 1” or “CTR TONE 2.”

To make the dialogue clearer, select “CTR TONE 4” or “CTR TONE 5.”

When “CTR TONE 3” is selected, no adjustment is applied.

- 4. Adjust the overall levels of the effect.**

- 1) Press EFFECT repeatedly until “EFFECT” appears on the display.

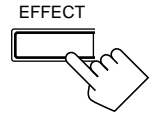

The display changes to show the current setting.

- 2) Press CONTROL UP ▲/DOWN ▼ to select the effect level you want.

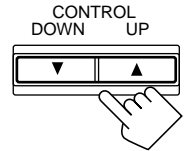

- Each time you press the button, the display changes to show the following:

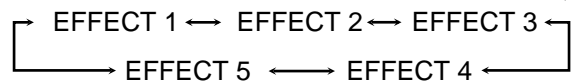

As the number increases, the selected DAP effect becomes stronger. (Normally set it to “EFFECT 3.”)

- 5. Adjust the room size (sense of spaciousness).**

- 1) Press EFFECT repeatedly until “ROOM SIZE” appears on the display.

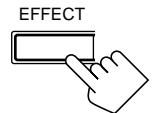

The display changes to show the current setting.

- 2) Press CONTROL UP ▲/DOWN ▼ to select the room size you want.

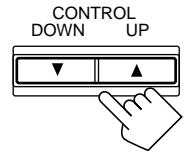

- Each time you press the button, the display changes to show the following:

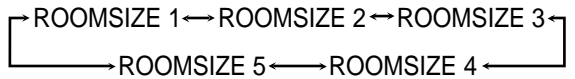

As the number increases, the interval between reflections increases so that you will feel as if you were in a larger room. (Normally set it to “ROOMSIZE 3.”)

- 6. Adjust the liveness.**

- 1) Press EFFECT repeatedly until “LIVENESS” appears on the display.

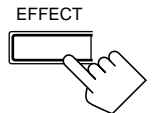

The display changes to show the current setting.

- 2) Press CONTROL UP ▲/DOWN ▼ to select the liveness level you want.

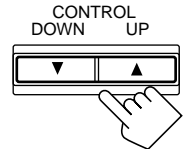

- Each time you press the button, the display changes to show the following:

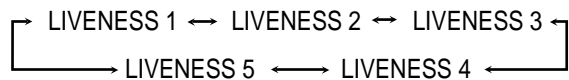

As the number increases, the attenuation level of reflections over time decreases so that acoustics change from “Dead” to “Live.” (Normally set it to “LIVENESS 3.”)

From the remote control:

1. Press **DSP MODE** repeatedly until the **DAP mode you want to adjust** — **THEATER 1, THEATER 2, HALL 1, HALL 2, LIVE CLUB, DANCE CLUB, or PAVILION** — appears on the display.

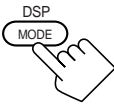

The DSP MODE lamp on the front panel button lights up, and the DSP indicator also lights up on the display.

- When you have set “REAR SPK” to “NONE,” the 3D-PHONIC indicator also lights up.

2. Press **SOUND**.

The 10 keys are activated for sound adjustments.

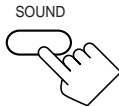

3. Select the speaker you want to adjust.

- To select the center speaker level, press **CENTER**.
- To select the left rear speaker level, press **REAR•L**.
- To select the right rear speaker level, press **REAR•R**.



4. Press **LEVEL +** or **LEVEL -** to adjust the speaker output levels (–10 dB to +10 dB).

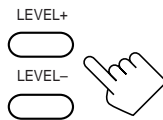

- Each time you press the button, the indication corresponding to the button selected in step 3 appears on the display window on the remote control.

5. Repeat steps 3 and 4 to adjust the other speaker output levels.

6. Press **CENTER TONE** to select the center tone level you want.

- Each time you press the button, the display changes to show the following:

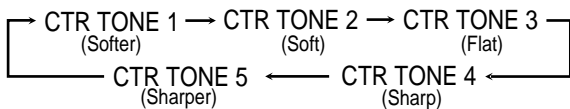

To make the dialogue softer, select “CTR TONE 1” or “CTR TONE 2.”

To make the dialogue clearer, select “CTR TONE 4” or “CTR TONE 5.”

When “CTR TONE 3” is selected, no adjustment is applied.

7. Press **EFFECT** to adjust the overall level of the effect.

- Each time you press the button, the effect level changes as follows:

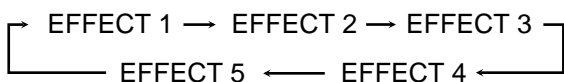

As the number increases, the selected DAP effect becomes stronger. (Normally set it to “EFFECT 3.”)

8. Press **ROOM SIZE** to adjust the room size (sense of spaciousness).

- Each time you press the button, the display changes to show the following:

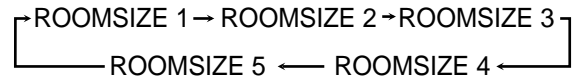

As the number increases, the interval between reflections increases so that you will feel as if you were in a larger room. (Normally set it to “ROOMSIZE 3.”)

9. Press **LIVENESS** to adjust the liveness.

- Each time you press the button, the display changes to show the following:

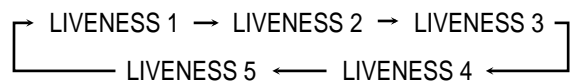

As the number increases, the attenuation level of reflections over time decreases so that acoustics change from “Dead” to “Live.” (Normally set it to “LIVENESS 3.”)

Adjusting the Surround Modes with the DAP Modes

IMPORTANT:

Check to see if the proper indicator(s) and information appear on the display on the front panel before/while using the buttons and controls.

For the main room operations:

- The MAIN ROOM indicator is lit.
- The source name for the sub-room is not lit on the display.

When using the remote control:

- Set MAIN ROOM/SUB ROOM selector to “MAIN ROOM.”

- Check to see if the following information appear on the display window on the remote control.

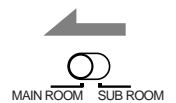

Buttons	Indications
SOUND	SOUND

After pressing SOUND, the following function are assigned to the specific number buttons:

Buttons	Indications
EFFECT	SOUND
ROOM SIZE	
LIVENESS	
CENTER TONE	
CENTER	CTR
REAR•L	REARL
REAR•R	REARR



Ex. “SOUND” appears on the display window.



When you press the buttons listed above, the indication appears for 5 – 10 seconds for your confirmation.

Before you start, remember...

- **Make sure that you have set the speaker information correctly (see page 29).**
- This function does not work when you activate the sub-room.
- There is a time limit in doing the following steps. If the setting is canceled before you finish, start from step 4 again.
- You cannot adjust the rear speaker output levels when you have set "REAR SPK" to "NONE." See page 29.
- You cannot adjust the center speaker output level and center tone when you have set "CTR SPK" to "NONE." See page 29.
- To adjust the front speaker output balance and subwoofer output level, see pages 27 and 28.

From the remote control:

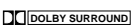
1. Select and play a sound source.

- To enjoy Dolby Pro Logic, play back a software encoded with Dolby Surround and labeled with  mark.
- To enjoy Dolby Digital, play back a software encoded with Dolby Digital and labeled with  mark.
- To enjoy DTS Digital Surround, play back a software encoded with DTS Digital Surround and labeled with  mark.

2. Press SURROUND ON/OFF to activate an appropriate Surround mode — PRO LOGIC, DOLBY DIGITAL or DTS SURROUND.



The SURROUND ON/OFF lamp on the front panel button lights up.

- Each time you press the button, the Surround mode turns on and off alternately.
- When "PRO LOGIC" is selected, the PRO LOGIC indicator lights up on the display.

3. Press DSP MODE repeatedly until the DAP mode you want to adjust — THEATER 1, THEATER 2, HALL 1, HALL 2, LIVE CLUB, DANCE CLUB, or PAVILION — appears on the display.

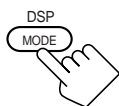

The DSP MODE lamp on the front panel button lights up, and the DSP indicator also lights up on the display.

4. Press TEST to check the speaker output balance.

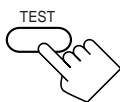

"TEST TONE L" starts flashing on the display, and a test tone comes out of the speakers in the following order:

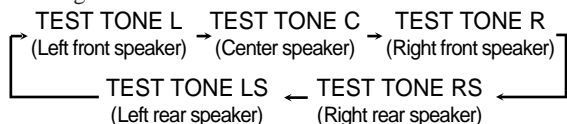

Notes:

- You can adjust the speaker output levels without outputting the test tone.
- No test tone comes out of the center speaker when "CTR SPK" is set to "NONE" (see page 29).
- No test tone comes out of the rear speakers when "REAR SPK" is set to "NONE" (see page 29).
- If the TV is turned on and the proper video input is selected on the TV, the test tone screen will appear on the TV.

5. Press SOUND.

The 10 keys are activated for sound adjustments.

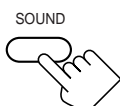

6. Select the speaker you want to adjust.

- To select the center speaker level, press CENTER.
- To select the left rear speaker level, press REAR•L.
- To select the right rear speaker level, press REAR•R.



7. Press LEVEL + or LEVEL – to adjust the speaker output levels (– 10 dB to +10 dB).

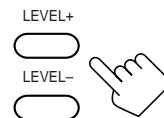

- Each time you press the button, the indication corresponding to the button selected in step 6 appears on the display window on the remote control.

8. Repeat steps 6 and 7 to adjust the other speaker output levels.

9. Press TEST again to stop the test tone.

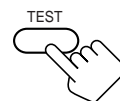

10. Press CENTER TONE to select the center tone level you want.



The center tone adjustment affects the mid-frequency range, which the human voice is mostly made up of.

- Each time you press the button, the display changes to show the following:

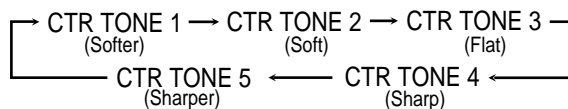

To make the dialogue softer, select "CTR TONE 1" or "CTR TONE 2."

To make the dialogue clearer, select "CTR TONE 4" or "CTR TONE 5."

When "CTR TONE 3" is selected, no adjustment is applied.

11. Press EFFECT to adjust the overall level of the effect.



- Each time you press the button, the effect level changes as follows:

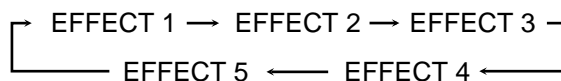

As the number increases, DAP effect becomes stronger. (Normally set it to "EFFECT 3.")

12. Press ROOM SIZE to adjust the room size (sense of spaciousness).



- Each time you press the button, the display changes to show the following:

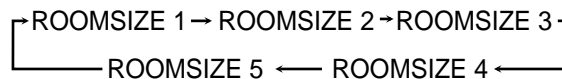

As the number increases, the interval between reflections increases so that you will feel as if you were in a larger room. (Normally set it to "ROOMSIZE 3.")

Continued to the next page.

13. Press LIVENESS to adjust the liveness.

- Each time you press the button, the display changes to show the following:

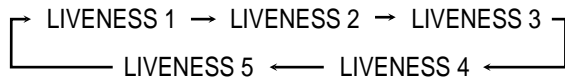

As the number increases, the attenuation level of reflections over time decreases so that acoustics change from “Dead” to “Live.” (Normally set it to “LIVENESS 3.”)

On the front panel:

You can also use the buttons on the front panel to adjust the sound with a Surround mode and a DAP mode. However, no test tone is available when using the buttons on the front panel. So, make adjustments while listening to the sound of the source played back.

1. Select and play a sound source.

- To enjoy Dolby Pro Logic, play back a software encoded with Dolby Surround and labeled with mark.
- To enjoy Dolby Digital, play back a software encoded with Dolby Digital and labeled with mark.
- To enjoy DTS Digital Surround, play back a software encoded with DTS Digital Surround and labeled with mark.

2. Press SURROUND ON/OFF to activate an appropriate Surround mode — PRO LOGIC, DOLBY DIGITAL or DTS SURROUND.

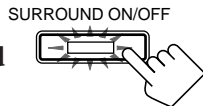

The SURROUND ON/OFF lamp on the front panel button lights up.

- Each time you press the button, the Surround mode turns on and off alternately.
- When “PRO LOGIC” is selected, the PRO LOGIC indicator lights up on the display.

3. Press DSP MODE repeatedly until the DAP mode you want to adjust — THEATER 1, THEATER 2, HALL 1, HALL 2, LIVE CLUB, DANCE CLUB, or PAVILION — appears on the display.

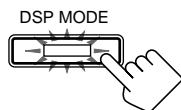

The DSP MODE lamp on the front panel button lights up, and the DSP indicator also lights up on the display.

4. Adjust the speaker output levels.

- 1) Press LEVEL ADJUST repeatedly until one of the following indications appears on the display.



“CENTER”:

To adjust the center speaker level.

“REAR L”:

To adjust the left rear speaker level.

“REAR R”:

To adjust the right rear speaker level.

- 2) Press CONTROL UP ▲/DOWN ▼ to adjust the selected speaker output level (from -10 dB to +10 dB).

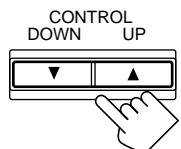

- 3) Repeat 1) and 2) to adjust the other speaker output levels.

5. Adjust the center tone.

- 1) Press EFFECT repeatedly until “CTR TONE” appears on the display.

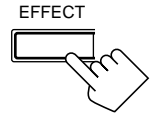

The display changes to show the current setting.

- 2) Press CONTROL UP ▲/DOWN ▼ to select the center tone level you want.

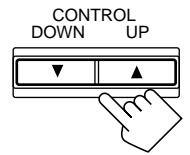

- Each time you press the button, the display changes to show the following:

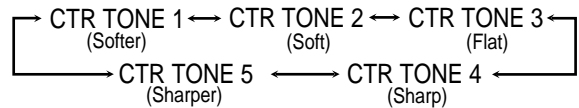

To make the dialogue softer, select “CTR TONE 1” or “CTR TONE 2.”

To make the dialogue clearer, select “CTR TONE 4” or “CTR TONE 5.”

When “CTR TONE 3” is selected, no adjustment is applied.

6. Adjust the overall levels of the effect.

- 1) Press EFFECT repeatedly until “EFFECT” appears on the display.

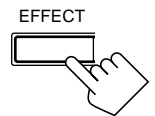

The display changes to show the current setting.

- 2) Press CONTROL UP ▲/DOWN ▼ to select the effect level you want.

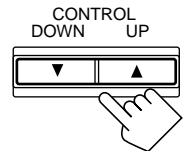

- Each time you press the button, the display changes to show the following:

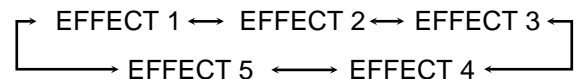

As the number increases, DAP effect becomes stronger. (Normally set it to “EFFECT 3.”)

7. Adjust the room size (sense of spaciousness).

- 1) Press EFFECT repeatedly until “ROOM SIZE” appears on the display.

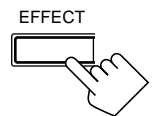

The display changes to show the current setting.

- 2) Press CONTROL UP ▲/DOWN ▼ to select the room size you want.

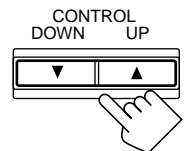

- Each time you press the button, the display changes to show the following:

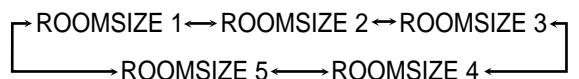

As the number increases, the interval between reflections increases so that you will feel as if you were in a larger room. (Normally set it to “ROOMSIZE 3.”)

8. Adjust the liveness.

- 1) Press **EFFECT** repeatedly until **“LIVENESS”** appears on the display. The display changes to show the current setting.
- 2) Press **CONTROL UP ▲/DOWN ▼** to select the liveness level you want.
 - Each time you press the button, the display changes to show the following:

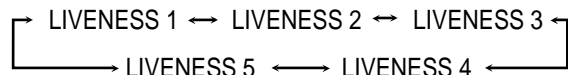
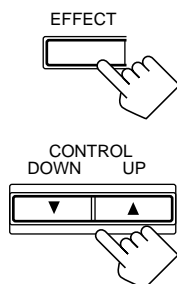

As the number increases, the attenuation level of reflections over time decreases so that acoustics change from “Dead” to “Live.” (Normally set it to “LIVENESS 3.”)

Adjusting the 5 CH/4 CH Stereo Mode

IMPORTANT:

Check to see if the proper indicator(s) and information appear on the display on the front panel before/while using the buttons and controls.

For the main room operations:

- The MAIN ROOM indicator is lit.
- The source name for the sub-room is not lit on the display.
- **When using the remote control:**
 - Set MAIN ROOM/SUB ROOM selector to **“MAIN ROOM.”**
 - Check to see if the following information appear on the display window on the remote control.

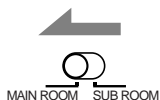

Buttons	Indications
SOUND	SOUND

After pressing SOUND, the following function are assigned to the specific number buttons:

Buttons	Indications
CENTER TONE	SOUND
CENTER	CTR
REAR•L	REARL
REAR•R	REARR

Ex. “SOUND” appears on the display window.



When you press the buttons listed above, the indication appears for 5 – 10 seconds for your confirmation.

Before you start, remember...

- **Make sure that you have set the speaker information correctly (see page 29).**
- This function does not work when you activate the sub-room.
- There is a time limit in doing the following steps. If the setting is canceled before you finish, start from step 2 again.
- You cannot adjust the center speaker output level and select the center tone level for 4 CH Stereo mode.
- To adjust the front speaker output balance and subwoofer output level, see pages 27 and 28.

On the front panel:

1. Press **DSP MODE** repeatedly until **“5CH STEREO**”** appears on the display.

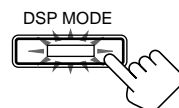

The DSP MODE lamp on the front panel button lights up, and the DSP indicator also lights up on the display.

* “4CH STEREO” appears on the display when you have set “CTR SPK” to “NONE.” (See page 29.)

2. Adjust the speaker output levels.

- 1) Press **LEVEL ADJUST** repeatedly until one of the following indications appears on the display.



“CENTER”: (for 5CH STEREO only)

To adjust the center speaker level.

“REAR L”:

To adjust the left rear speaker level.

“REAR R”:

To adjust the right rear speaker level.

- 2) Press **CONTROL UP ▲/DOWN ▼** to adjust the selected speaker output level (from –10 dB to +10 dB).
- 3) Repeat 1) and 2) to adjust the other speaker output levels.

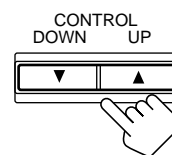

3. Adjust the center tone (for 5CH STEREO only.)

- 1) Press **EFFECT** repeatedly until **“CTR TONE”** appears on the display.

The display changes to show the current setting.

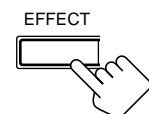

- 2) Press **CONTROL UP ▲/DOWN ▼** to select the center tone level you want.

- The center tone adjustment affects the mid-frequency range, which the human voice is mostly made up of.

- Each time you press the button, the display changes to show the following:

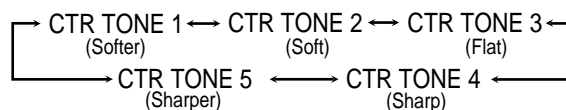
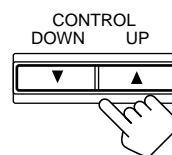

To make the dialogue softer, select “CTR TONE 1” or “CTR TONE 2.”

To make the dialogue clearer, select “CTR TONE 4” or “CTR TONE 5.”

When “CTR TONE 3” is selected, no adjustment is applied.

Continued to the next page.

From the remote control:

1. Press **DSP MODE** repeatedly until **“5CH STEREO*”** appears on the display.

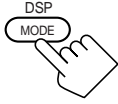

The DSP MODE lamp on the front panel button lights up, and the DSP indicator also lights up on the display.

*“4CH STEREO” appears on the display when you have set “CTR SPK” to “NONE.” (See page 29.)

2. Press **SOUND**.

The 10 keys are activated for sound adjustments.

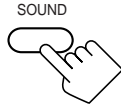

3. Select the speaker you want to adjust.

- To select the center speaker level, press **CENTER** (for 5CH STEREO only).
- To select the left rear speaker level, press **REAR•L**.
- To select the right rear speaker level, press **REAR•R**.



4. Press **LEVEL +** or **LEVEL -** to adjust the speaker output levels (-10 dB to +10 dB).

- Each time you press the button, the indication corresponding to the button selected in step 3 appears on the display window on the remote control.

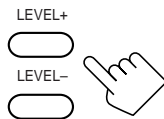

5. Repeat steps 3 and 4 to adjust the other speaker output levels.

6. Press **CENTER TONE** to select the center tone level you want (for 5CH STEREO only).



- The center tone adjustment affects the mid-frequency range, which the human voice is mostly made up of.
- Each time you press the button, the display changes to show the following:

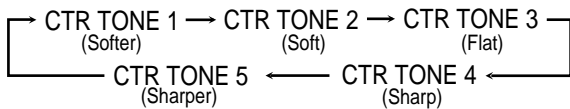

To make the dialogue softer, select “CTR TONE 1” or “CTR TONE 2.”

To make the dialogue clearer, select “CTR TONE 4” or “CTR TONE 5.”

When “CTR TONE 3” is selected, no adjustment is applied.

Adjusting the 3D-PHONIC Modes

Once you have adjusted the 3D-PHONIC modes, the adjustment is memorized for each source.

IMPORTANT:

Check to see if the proper indicator(s) and information appear on the display on the front panel before/while using the buttons and controls.

For the main room operations:

- The MAIN ROOM indicator is lit.
- The source name for the sub-room is not lit on the display.

When using the remote control:

- Set MAIN ROOM/SUB ROOM selector to **“MAIN ROOM.”**
- Check to see if the following information appear on the display window on the remote control.

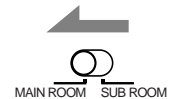

Buttons	Indications
SOUND	SOUND

After pressing SOUND, the following function are assigned to the specific number buttons:

Buttons	Indications
EFFECT	SOUND
CENTER TONE	
CENTER	CTR
REAR•L	REARL
REAR•R	REARR

Ex. “SOUND” appears on the display window.



When you press the buttons listed above, the indication appears for 5 – 10 seconds for your confirmation.

Before you start, remember..

- **Make sure that you have set the speaker information correctly (see page 29).**
- There is a time limit in doing the following steps. If the setting is canceled before you finish, start from step 2 again.
- You cannot adjust the center speaker output level when you have set “CTR SPK” to “NONE” See page 29.
- To adjust the front speaker output balance and subwoofer output level, see pages 27 and 28.

On the front panel:

1. Press **DSP MODE** repeatedly until “3D ACTION” or “3D DIGITAL” appears on the display.

The DSP MODE lamp on the front panel button lights up, and the 3D-PHONIC and DSP indicators also light up on the display.

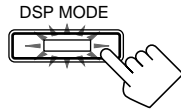

2. Adjust the center speaker output level.

- 1) Press **LEVEL ADJUST** repeatedly until “CENTER” appears on the display.
- 2) Press **CONTROL UP ▲/DOWN ▼** to adjust the center speaker output level (from -10 dB to +10 dB).

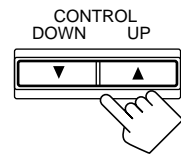

3. Adjust the center tone.

- 1) Press **EFFECT** repeatedly until “CTR TONE” appears on the display. The display changes to show the current setting.
- 2) Press **CONTROL UP ▲/DOWN ▼** to select the center tone level you want.

The center tone adjustment affects the mid-frequency range, which the human voice is mostly made up of.

- Each time you press the button, the display changes to show the following:

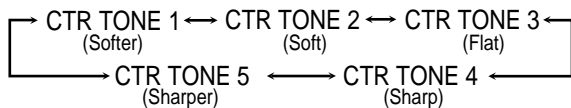
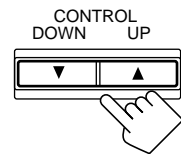
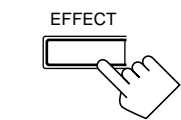

To make the dialogue softer, select “CTR TONE 1” or “CTR TONE 2.”

To make the dialogue clearer, select “CTR TONE 4” or “CTR TONE 5.”

When “CTR TONE 3” is selected, no adjustment is applied.

4. Adjust the overall levels of the effect.

- 1) Press **EFFECT** repeatedly until “EFFECT” appears on the display. The display changes to show the current setting.
- 2) Press **CONTROL UP ▲/DOWN ▼** to select the effect level you want.
 - Each time you press the button, the display changes to show the following:

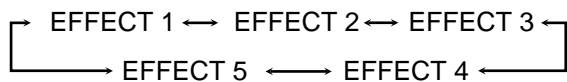
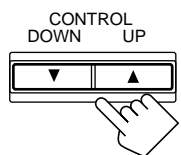
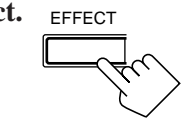

As the number increases, the selected 3D effect mode becomes stronger. (Normally set it to “EFFECT 3.”)

From the remote control:

1. Press **DSP MODE** repeatedly until “3D ACTION” or “3D DIGITAL” appears on the display.

The DSP MODE lamp on the front panel button lights up, and the 3D-PHONIC and DSP indicators also light up on the display.

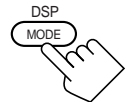

2. Press **SOUND**.

The 10 keys are activated for sound adjustments.

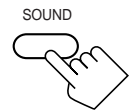

3. Press **CENTER** to select the center speaker.



4. Press **LEVEL +** or **LEVEL -** to adjust the center speaker output levels (from -10 dB to +10 dB).

- Each time you press the button, “CTR” appears on the display window on the remote control.



5. Press **CENTER TONE** to select the center tone level you want.

- Each time you press the button, the display changes to show the following:

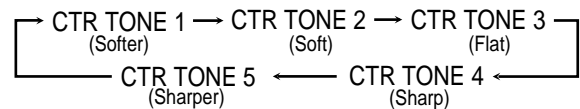
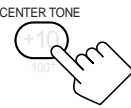

To make the dialogue softer, select “CTR TONE 1” or “CTR TONE 2.”

To make the dialogue clearer, select “CTR TONE 4” or “CTR TONE 5.”

When “CTR TONE 3” is selected, no adjustment is applied.

6. Press **EFFECT** to adjust the overall level of the effect.

- Each time you press the button, the effect level changes as follows:

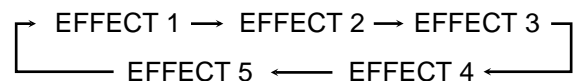

As the number increases, 3D effect mode becomes stronger. (Normally set it to “EFFECT 3.”)

Using the DVD MULTI Playback Mode

This receiver provides the DVD MULTI playback mode for reproducing the analog discrete output mode of the DVD player. Before playing back a DVD, refer also to the manual supplied for the DVD player.

- You can use "On-screen Menu" for most of the main room operations. For details, see page 50.

The following operations are only possible while the receiver is ready for the main room operations, and are only used for the main room source — DVD MULTI.

IMPORTANT:

Check to see if the proper indicator(s) and information appear on the display on the front panel before/while using the buttons and controls.

For the main room operations:

- The MAIN ROOM indicator is lit.
- The source name for the sub-room is not lit on the display.

When using the remote control:

- Set MAIN ROOM/SUB ROOM selector to "MAIN ROOM."
- Check to see if the following information appear on the display window on the remote control.

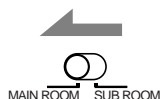

Buttons	Indications
SOUND	SOUND

After pressing SOUND, the following function are assigned to the specific number buttons:

Buttons	Indications
CENTER	CTR
REAR•L	REARL
REAR•R	REARR

Activating the DVD MULTI Playback Mode

You can adjust the DVD MULTI playback mode while playing back a DVD using the analog discrete output mode on the DVD player. Once you have made adjustments, the receiver memorizes the adjustments until you change them. You also need to set the DVD player to the analog discrete output mode.

Before you start, remember...

- When the SUB ROOM and the SPEAKERS SUB ROOM indicators are lit on the display, you cannot select "DVD MULTI" as the main room source.
- There is a time limit in doing the following steps. If the setting is canceled before you finish, start from step 3 again.
- To adjust the front speaker output balance and subwoofer output level, see pages 27 and 28.

On the front panel:

- Press DVD MULTI so that "DVD MULTI" appears on the display.



Note:

When you select "DVD MULTI" as the main room source to play, the Surround /DSP modes are canceled temporarily, and the SURROUND ON/OFF and DSP MODE buttons do not work.

- Select the analog discrete output mode on the DVD player, and start playing a DVD.

- Refer to the manual supplied with the DVD player.

If you need to make any adjustment, go to the following steps.

- Adjust the speaker output levels.

- 1) Press LEVEL ADJUST repeatedly until one of the following indications appears on the display.



"CENTER":

To adjust the center speaker level.

"REAR L":

To adjust the left rear speaker level.

"REAR R":

To adjust the right rear speaker level.

- 2) Press CONTROL UP ▲/DOWN ▼ to adjust the selected speaker output level (from -10 dB to +10 dB).

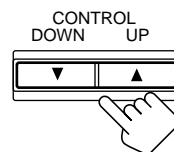

- 3) Repeat 1) and 2) to adjust the other speaker output levels.

Notes:

- You cannot adjust the center tone level.
- You cannot use the Midnight Mode for DVD MULTI playback mode (see page 21).
- When using a pair of headphones, the sounds of front left and right are outputted from the headphones.

From the remote control:

1. Press DVD MULTI so that "DVD MULTI" appears on the display.



Note:

When you select "DVD MULTI" as the main room source to play, the Surround/DSP modes are canceled temporarily, and the SURROUND ON/OFF and DSP MODE buttons do not work.

2. Select the analog discrete output mode on the DVD player, and start playing a DVD.

- Refer to the manual supplied with the DVD player.

If you need to make any adjustment, go to the following steps.

3. Press SOUND.

The 10 keys are activated for adjusting the sound.

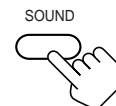

4. Select the speaker you want to adjust.

- To select the center speaker level, press CENTER.
- To select the left rear speaker level, press REAR•L.
- To select the right rear speaker level, press REAR•R.



5. Press LEVEL + or LEVEL - to adjust the speaker output levels (from -10 dB to +10 dB).

- Each time you press the button, the indication corresponding to the button selected in step 4 appears on the display window on the remote control.

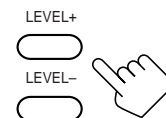

6. Repeat steps 4 and 5 to adjust the other speaker output levels.

Using the On-Screen Menus

You use the black-and-white color Menus on the TV screen to control the receiver.

To use this function, you need to connect the TV to the MONITOR OUT jack on the rear panel (see page 9), and set the TV's input mode to the proper position to which the receiver is connected.

- When the TV's input mode is incorrect; for example, a different video input or TV tuner mode is selected, you cannot show the Menus on the TV screen.

The following operations are only possible while the receiver is ready for the main room operations, and are used for the main room sources.

IMPORTANT:

Check to see if the proper indicator(s) and information appear on the display on the front panel before/while using the buttons and controls.

For the main room operations:

- The MAIN ROOM indicator is lit.
- The source name for the sub-room is not lit on the display.
- **When using the remote control:**
 - Set MAIN ROOM/SUB ROOM selector to “MAIN ROOM.”
 - Check to see if the following information appear on the display window on the remote control.

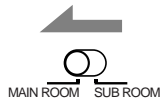

On-Screen Operation buttons (on the remote control)

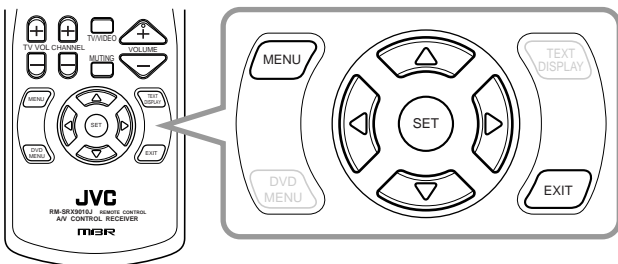

“MENU” appears on the display window of the remote control when you press the buttons — MENU, $\Delta / \nabla / \triangleleft / \triangleright$, SET, EXIT.

Ex. When you press MENU with the multi-room operation selector set to “MAIN ROOM.”

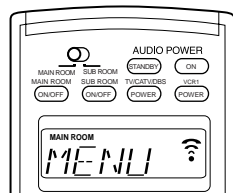

Showing the MENU on the TV Screen

Press MENU.

The MENU appears on the TV.

- Pressing one of the $\Delta / \nabla / \triangleleft / \triangleright$ buttons also displays the MENU.

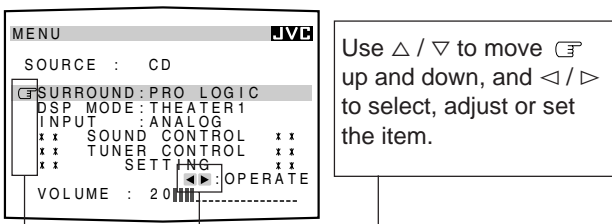

Notes:

- “INPUT” appears only when the digital input (DIGITAL IN) terminal setting has been correctly done for the digital source currently selected. (See page 30.)
- The on-screen display will disappear if no operation is done for about 1 minute.

Activating the Surround Modes

(Also see page 40)

1. Press MENU.

The MENU appears on the TV.

- Pressing one of the $\Delta / \nabla / \triangleleft / \triangleright$ buttons also displays the MENU.

2. Press Δ / ∇ to move to “SURROUND.”

3. Press $\triangleleft / \triangleright$ to select the Surround mode you want to use.

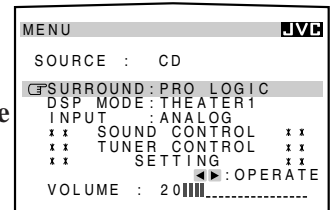

4. When you finish, press EXIT.

The menu disappears from the TV.

Activating the DAP Modes

(Also see page 41)

1. Press MENU.

The MENU appears on the TV.

- Pressing one of the $\Delta / \nabla / \triangleleft / \triangleright$ buttons also displays the MENU.

2. Press Δ / ∇ to move to “DSP MODE.”

3. Press $\triangleleft / \triangleright$ to select the DSP mode you want to use.

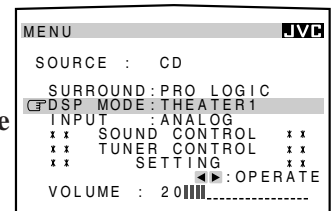

4. When you finish, press EXIT.

The menu disappears from the TV.

Note:

If “DVD MULTI” is selected as a playing source, “SURROUND” and “DSP MODE” do not appear on the display.

Selecting the Analog or Digital Input Mode

(Also see page 31)

This selection is only possible when the digital input (DIGITAL IN) terminal setting has been correctly done for the digital source currently selected. (See page 30.)

1. Press MENU.

The MENU appears on the TV.

- Pressing one of the $\Delta / \nabla / \triangleleft / \triangleright$ buttons also displays the MENU.

2. Press Δ / ∇ to move to “INPUT.”

3. Press $\triangleleft / \triangleright$ to select the analog or digital input mode you want.

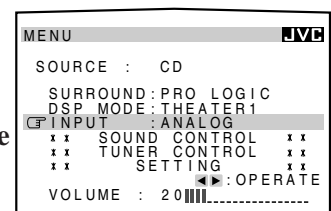

4. When you finish, press EXIT.

The menu disappears from the TV.

■ Adjusting the Equalization Patterns

(Also see page 20)

1. Press MENU.

The MENU appears on the TV.

- Pressing one of the Δ / ∇ / \triangleleft / \triangleright buttons also displays the MENU.

2. Press Δ / ∇ to move \leftarrow to “SOUND CONTROL,” then press \triangleleft / \triangleright .

The SOUND CONTROL menu appears.

3. Press Δ / ∇ to move \leftarrow to “DIGITAL EQ,” then press \triangleleft / \triangleright .

The DIGITAL EQ menu appears.

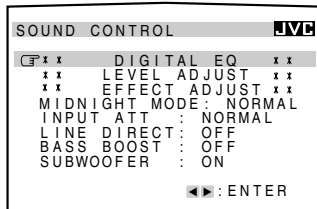

4. Press Δ / ∇ to move \leftarrow to the frequency you want to adjust.

5. Press \triangleleft / \triangleright to adjust the frequency level you want.

The frequency level changes by 2 dB from -8 dB to +8 dB.

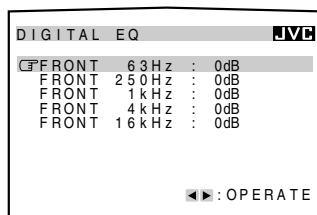

6. When you finish, press EXIT repeatedly until the menu disappears from the TV.

■ Adjusting the Surround and DSP Modes

(Also see pages 40 – 48)

You can use a Surround mode with a DAP mode, but not with the 5 CH/4 CH Stereo mode and 3D PHONIC mode.

1. Press MENU.

The MENU appears on the TV.

- Pressing one of the Δ / ∇ / \triangleleft / \triangleright buttons also displays the MENU.

2. Select Surround mode and/or DSP mode you like to adjust (see page 50).

3. Press Δ / ∇ to move \leftarrow to “SOUND CONTROL,” then press \triangleleft / \triangleright .

The SOUND CONTROL menu appears.

4. Press Δ / ∇ to move \leftarrow to “LEVEL ADJUST,” then press \triangleleft / \triangleright .

The LEVEL ADJUST menu appears.

5. Press Δ / ∇ to move \leftarrow to the item you want to set or adjust, then press \triangleleft / \triangleright .

On these adjustment menus, you can do the following:

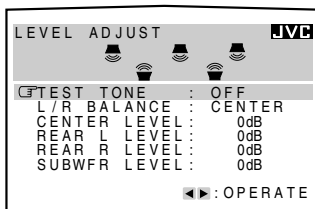
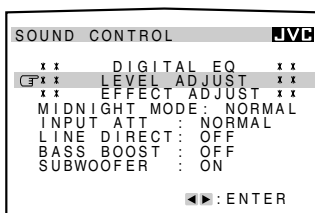

For Surround modes and Surround mode with DAP mode:

- “TEST TONE”: Output a test tone.
- “L/R BALANCE”: Adjust the right and left balance of the front speakers.
- “CENTER LEVEL”: Adjust the center speaker output level. *
- “REAR L LEVEL”: Adjust the left rear speaker output level. **
- “REAR R LEVEL”: Adjust the right rear speaker output level. **
- “SUBWFR LEVEL”: Adjust the subwoofer output level. ***

For DAP mode:

- “L/R BALANCE”: Adjust the right and left balance of the front speakers.
- “CENTER LEVEL”: Adjust the center speaker output level. *
- “REAR L LEVEL”: Adjust the left rear speaker output level. **
- “REAR R LEVEL”: Adjust the right rear speaker output level. **
- “SUBWFR LEVEL”: Adjust the subwoofer output level. ***

For 5 CH/4 CH Stereo mode:

- “L/R BALANCE”: Adjust the right and left balance of the front speakers.
- “CENTER LEVEL”: Adjust the center speaker output level. ****
- “REAR L LEVEL”: Adjust the left rear speaker output level. **
- “REAR R LEVEL”: Adjust the right rear speaker output level. **
- “SUBWFR LEVEL”: Adjust the subwoofer output level. ***

For 3D-PHONIC mode:

- “L/R BALANCE”: Adjust the right and left balance of the front speakers.
- “CENTER LEVEL”: Adjust the center speaker output level. *
- “SUBWFR LEVEL”: Adjust the subwoofer output level. ***

For Surr. OFF (DSP OFF):

- “L/R BALANCE”: Adjust the right and left balance of the front speakers.
- “SUBWFR LEVEL”: Adjust the subwoofer output level. ***

Notes:

- * You cannot select “CENTER LEVEL” when “CTR SPK” is set to “NONE” (see page 29).
- ** You cannot select both “REAR L LEVEL” and “REAR R LEVEL” when “REAR SPK” is set to “NONE” (see page 29).
- *** You cannot select “SUBWFR LEVEL” when “SUBWFR” is set to “NO” (see page 28).
- **** You cannot select “CENTER LEVEL” when 4 CH Stereo mode is selected.

6. Press EXIT once.

7. Press Δ / ∇ to move \mathcal{C} to “EFFECT ADJUST,” then press $\triangleleft / \triangleright$.

The EFFECT LEVEL menu appears.

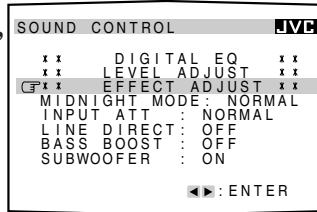

8. Press Δ / ∇ to move \mathcal{C} to the item you want to adjust, then press $\triangleleft / \triangleright$.

On these adjustment menus, you can do the following.

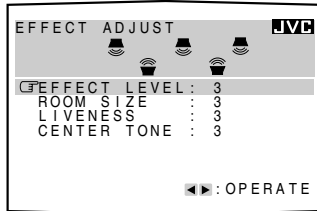

For Surround mode:

“CENTER TONE”: Select the center tone level. *

For Surround with DAP mode, DAP mode:

“EFFECT LEVEL”: Adjust the surround effect level.
 “ROOM SIZE”: Adjust the room size effect.
 “LIVENESS”: Adjust the liveness level.
 “CENTER TONE”: Select the center tone level. *

For 5 CH Stereo mode:

“CENTER TONE”: Select the center tone level.

For 3D-PHONIC mode:

“EFFECT LEVEL”: Adjust the surround effect level.
 “CENTER TONE”: Select the center tone level. *

Note:

- You cannot select “EFFECT ADJUST” in step 7, when both of the Surround and DSP modes are deactivated.
- You cannot select “CENTER TONE” when “CTR SPK” is set to “NONE” (see page 29).

9. When you finish, press EXIT repeatedly until the menu disappears from the TV.

Adjusting the DVD MULTI Playback Mode
 (Also see page 49)

- Select DVD MULTI as the playing source.
Press DVD MULTI.
- Press MENU.
The MENU appears on the TV.
• Pressing one of the $\Delta / \nabla / \triangleleft / \triangleright$ buttons also displays the MENU.
- Press Δ / ∇ to move \mathcal{C} to “SOUND CONTROL,” then press $\triangleleft / \triangleright$.
The SOUND CONTROL menu appears.
- Press Δ / ∇ to move \mathcal{C} to “LEVEL ADJUST,” then press $\triangleleft / \triangleright$.

The LEVEL ADJUST menu appears.

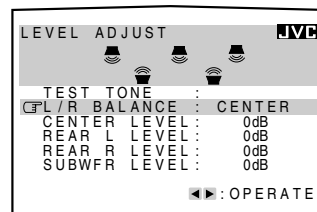

5. Press Δ / ∇ to move \mathcal{C} to the item you want to set or adjust, then press $\triangleleft / \triangleright$.

On this adjustment menu, you can do the following:

- “L/R BALANCE”: Adjust the right and left balance of the front speakers .
- “CENTER LEVEL”: Adjust the center speaker output level.
- “REAR L LEVEL”: Adjust the left rear speaker output level.
- “REAR R LEVEL”: Adjust the right rear speaker output level.
- “SUBWFR LEVEL”: Adjust the subwoofer output level.

6. When you finish, press EXIT repeatedly until the menu disappears from the TV.

Listening at Night — Midnight Mode
 (Also see page 21)

- Press MENU.
The MENU appears on the TV.
• Pressing one of the $\Delta / \nabla / \triangleleft / \triangleright$ buttons also displays the MENU.
- Press Δ / ∇ to move \mathcal{C} to “SOUND CONTROL,” then press $\triangleleft / \triangleright$.
The SOUND CONTROL menu appears.
- Press Δ / ∇ to move to “MIDNIGHT MODE.”
- Press $\triangleleft / \triangleright$ to select the mode you want to use.
- When you finish, press EXIT repeatedly until the menu disappears from the TV.

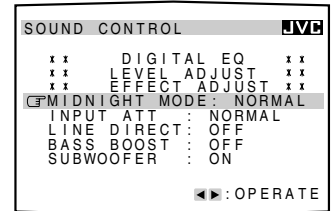

Attenuating the Input Signal
 (Also see page 21)

- Press MENU.
The MENU appears on the TV.
• Pressing one of the $\Delta / \nabla / \triangleleft / \triangleright$ buttons also displays the MENU.
- Press Δ / ∇ to move \mathcal{C} to “SOUND CONTROL,” then press $\triangleleft / \triangleright$.
The SOUND CONTROL menu appears.
- Press Δ / ∇ to move \mathcal{C} to “INPUT ATT.”
- Press $\triangleleft / \triangleright$ to select the Input Attenuator mode “ATT ON” or “NORMAL.”
- When you finish, press EXIT repeatedly until the menu disappears from the TV.

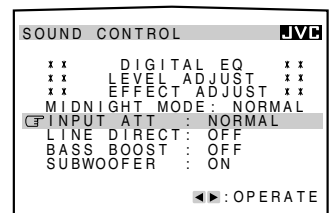

■ Selecting the Line Direct Function

(Also see page 22)

1. Press MENU.

The MENU appears on the TV.

- Pressing one of the Δ / ∇ / \triangleleft / \triangleright buttons also displays the MENU.

2. Press Δ / ∇ to move \square to “SOUND CONTROL,” then press \triangleleft / \triangleright .

The SOUND CONTROL menu appears.

3. Press Δ / ∇ to move \square to “LINE DIRECT.”

4. Press \triangleleft / \triangleright to turn the line direct function “ON” or “OFF.”

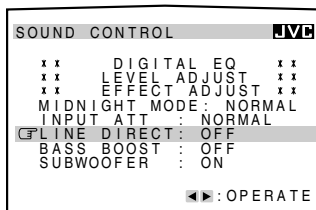

5. When you finish, press EXIT repeatedly until the menu disappears from the TV.

■ Selecting the Bass Boost Function

(Also see page 21)

1. Press MENU.

The MENU appears on the TV.

- Pressing one of the Δ / ∇ / \triangleleft / \triangleright buttons also displays the MENU.

2. Press Δ / ∇ to move \square to “SOUND CONTROL,” then press \triangleleft / \triangleright .

The SOUND CONTROL menu appears.

3. Press Δ / ∇ to move \square to “BASS BOOST.”

4. Press \triangleleft / \triangleright to turn the bass boost function “ON” or “OFF.”

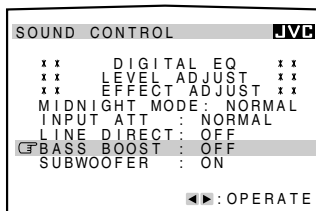

5. When you finish, press EXIT repeatedly until the menu disappears from the TV.

■ Activating the Subwoofer Sound

(Also see page 21)

1. Press MENU.

The MENU appears on the TV.

- Pressing one of the Δ / ∇ / \triangleleft / \triangleright buttons also displays the MENU.

2. Press Δ / ∇ to move \square to “SOUND CONTROL,” then press \triangleleft / \triangleright .

The SOUND CONTROL menu appears.

3. Press Δ / ∇ to move \square to “SUBWOOFER.”

4. Press \triangleleft / \triangleright to turn the subwoofer output “ON” or “OFF.”

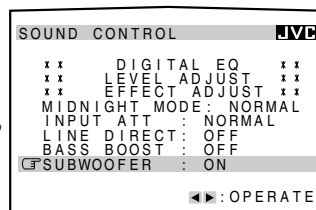

5. When you finish, press EXIT repeatedly until the menu disappears from the TV.

■ Operating the Tuner

(Also see pages 35 and 36)

1. Select FM or AM as the playing source.

Press FM/AM.

2. Press MENU.

The MENU appears on the TV.

- Pressing one of the Δ / ∇ / \triangleleft / \triangleright buttons also displays the MENU.

3. Press Δ / ∇ to move \square to “TUNER CONTROL,” then press \triangleleft / \triangleright .

The TUNER CONTROL menu appears.

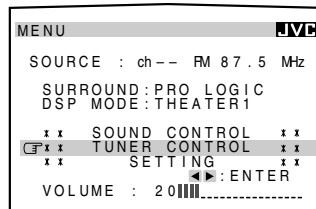

4. Press Δ / ∇ to move \square to the item you want to set, then press \triangleleft / \triangleright .

On the TUNER CONTROL menu, you can do the following:

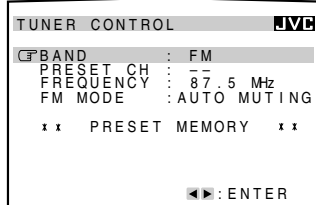

- | | |
|------------------|---|
| “BAND”: | Select the band. |
| “PRESET CH”: | Select a preset channel station. |
| “FREQUENCY”: | Tune in a station manually. |
| “FM MODE”: | Select the FM reception mode.* |
| “PRESET MEMORY”: | See “Storing the Preset Stations” on page 54. |

Note:

* Not displayed when an AM station is selected.

5. When you finish, press EXIT repeatedly until the menu disappears from the TV.

Storing the Preset Stations (Also see page 35)

1. Press MENU.

The MENU appears on the TV.

- Pressing one of the Δ / ∇ / \triangleleft / \triangleright buttons also displays the MENU.

2. Press Δ / ∇ to move \square to "TUNER CONTROL," then press \triangleleft / \triangleright .

The TUNER CONTROL menu appears.

3. Tune into a station on the TUNER CONTROL menu, referring to "Operating the Tuner" on page 53.

4. Press Δ / ∇ to move \square to "PRESET MEMORY," then press \triangleleft / \triangleright .

\square moves to "PRESET CH" and the channel number starts flashing.

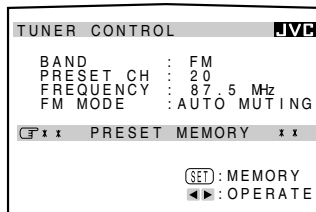

5. Press \triangleleft / \triangleright to select a preset station number you want.

6. Press SET to store the setting.

The selected channel number stops flashing.

7. When you finish, press EXIT repeatedly until the menu disappears from the TV.

Setting the Basic Setting Items

(Also see pages 27 – 34)

1. Press MENU.

The MENU appears on the TV.

- Pressing one of the Δ / ∇ / \triangleleft / \triangleright buttons also displays the MENU.

2. Press Δ / ∇ to move \square to "SETTING," then press \triangleleft / \triangleright .

The SETTING 1 appears.

3. Press Δ / ∇ to move \square to the item you want to set or adjust, then press \triangleleft / \triangleright .

- To go to the SETTING 2 menu, move \square to "NEXT PAGE," then press \triangleleft / \triangleright .
- To go back to the SETTING 1 menu, move \square to "PREVIOUS PAGE," then press \triangleleft / \triangleright .

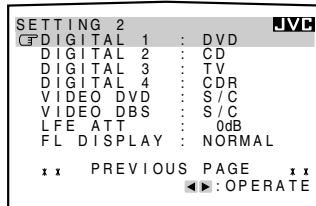
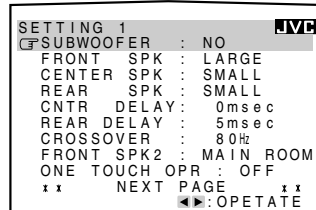
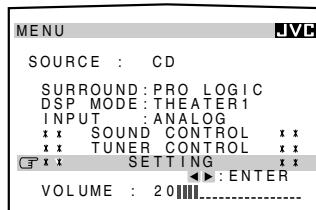

On the SETTING 1 and 2 menus, you can do the following:

SETTING 1 menu

- "SUBWOOFER": Set the subwoofer information (see page 28).
- "FRONT SPK": Set the front speaker information (see page 29).
- "CENTER SPK": Set the center speaker information (see page 29).
- "REAR SPK": Set the rear speaker information (see page 29).
- "CNTR DELAY": Adjust the delay time of the center speaker output (see page 29). *
- "REAR DELAY": Adjust the delay time of the rear speaker output (see page 29). **
- "CROSSOVER": Set the crossover frequency (see page 30).
- "FRONT SPK2": Set the front speaker 2 information (see page 27).
- "ONE TOUCH OPR": Set the one touch operation. (see page 34).

SETTING 2 menu

- "DIGITAL 1/2/3/4": Set the digital input terminal (see page 30).
- "VIDEO DVD": Set the video input terminal for the DVD player (see page 32).
- "VIDEO DBS": Set the video input terminal for the DBS tuner (see page 32).
- "LFE ATT": Set the low frequency effect attenuator level (see page 30).
- "FL DISPLAY": Shows the disc text information on the display (see page 33).

Notes:

* Not adjustable when "CTR SPK" is set to "NONE" (see page 29).

**Not adjustable when "REAR SPK" is set to "NONE" (see page 29).

4. When you finish, press EXIT repeatedly until the menu disappears from the TV.

COMPU LINK Remote Control System

The COMPU LINK remote control system allows you to operate JVC audio components through this receiver.

To use this remote control system, you need to connect JVC audio components through the COMPU LINK (SYNCHRO) jacks (see below) in addition to the connections using cables with RCA pin plugs (see pages 7 and 8).

- Make sure that the AC power cords of these components are unplugged before connection. Plug the AC power cords only after all connections are complete.

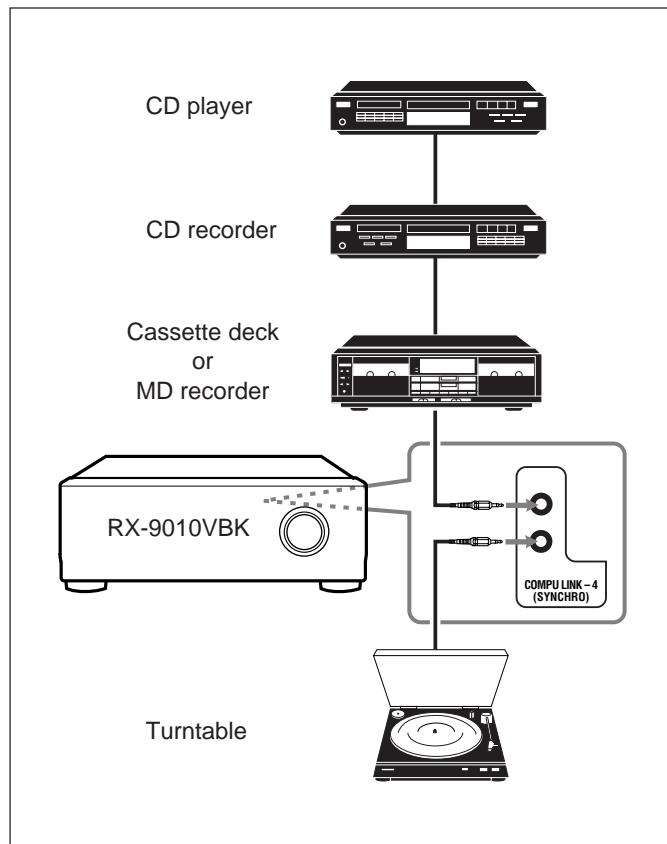

IMPORTANT:

Check to see if the proper indicator(s) and information appear on the display on the front panel before/while using the buttons and controls.

When using the buttons and controls on the front panel:

- **For the main room operations**
 - The MAIN ROOM indicator is lit.
 - The source name for the sub-room is not lit on the display.
- **For the sub-room operations**
 - The SUB ROOM indicator is lit.
 - The source name for the sub-room is lit on the display.

When using the remote control:

- **For the main room operations**
 - Set MAIN ROOM/SUB ROOM selector to “MAIN ROOM.”
- **For the sub-room operations**
 - Set MAIN ROOM/SUB ROOM selector to “SUB ROOM.”

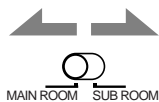

Notes:

- There are four versions of COMPU LINK remote control system. This receiver is equipped with the fourth version — COMPU LINK-4. This version is created by adding systematic operations with the CD recorder to the previous version — COMPU LINK-3.
- If your audio component has two COMPU LINK jacks, you can use either one. If it has only one COMPU LINK jack, connect it so that it is the last item in the series of components. (For example, the turntable or CD player in the diagram above.)
- To operate the cassette deck or MD recorder using the COMPU LINK remote control system, set the source name correctly. (See page 33.)
- Refer also to the manuals supplied with your audio components.

This remote control system allows you to use four functions listed below.

Remote Control through the Remote Sensor on the Receiver

You can control the connected audio components through the receiver using this remote control. For details, see pages 65 – 67.

Automatic Source Selection

- When you press the play (▶) button on a connected component or on its own remote control, the receiver automatically turns on and changes the **main room source** to the component.



- If the receiver is already turned on, and the SUB ROOM indicator and the source name for the sub-room are lit on the display, the receiver changes the **sub-room source** to the component.

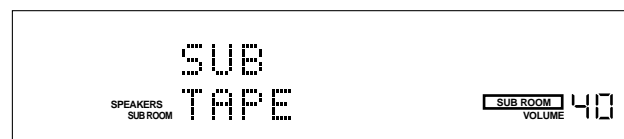

- When you press PLAY on the remote control supplied for this receiver, the receiver automatically turns on and changes the **main room source** or **sub-room source** (depending on MAIN ROOM/SUB ROOM selector setting on the remote control) to the target component.
- When you select a new source on the receiver or on the remote control supplied for this receiver either for **the main room** or **sub-room**, the newly selected component begins playing immediately, and the previously selected source continues playing without sound for a few seconds.



Automatic Power On/Off (Standby): only possible with the COMPU LINK-3 and COMPU LINK-4 connection

Automatic Power On:

- When you turn on the receiver by pressing **POWER** on the front panel or **AUDIO POWER ON** on the remote control (with **MAIN ROOM/SUB ROOM** selector set to “**MAIN ROOM**”):

OR

When you turn on the main room sound by pressing **MAIN ROOM ON/OFF** while the receiver is turned on:

- ➔ The **MAIN ROOM** indicator and the source name for the main room light up on the display, and one of the connected components will turn on automatically, depending on which component has been previously selected as the **main room source**.

- When you turn on the receiver by pressing **AUDIO POWER ON** on the remote control (with **MAIN ROOM/SUB ROOM** selector set to “**SUB ROOM**”):

OR

When you turn on the sub-room sound by pressing **SUB ROOM ON/OFF** while the receiver is turned on:

- ➔ The **SUB ROOM** indicator and the source name for the sub-room light up on the display, and one of the connected components will turn on automatically, depending on which component has been previously selected as the **sub-room source**.

Automatic Power Off (Standby):

- When you turn off the receiver by pressing **POWER**, the connected components will turn off (standby).
- When you turn off the main room sound by pressing **MAIN ROOM ON/OFF**, the selected **main room source** component turns off (unless the same component is selected as the sub-room source).
 - If the **SUB ROOM** indicator and the source name for the sub-room are lit on the display, the **main room source** will stop playing, but will not turn off.
- When you turn off the sub-room source by pressing **SUB ROOM ON/OFF**, the selected **sub-room source** component turns off (unless the same component is selected as the main room source).
 - If the **MAIN ROOM** indicator and the source name for the main room are lit on the display, the **main room source** will stop playing, but will not turn off.

Synchronized Recording

This operation is only possible while the receiver is ready for the main room operations.

Synchronized recording means the cassette deck (or MD recorder) starts recording as soon as a CD begins playing.

- When using a CD player for synchronized recording, refer to the manual supplied with it.

To use synchronized recording, follow these steps:

1. Put a tape in the cassette deck (or an MD in the MD recorder), and a disc in the CD player.
2. Press the record (●) button and the pause (II) button on the cassette deck (or MD recorder) at the same time.

This puts the cassette deck (or MD recorder) into recording pause.

If you do not press the record (●) button and pause (II) button at the same time, the synchronized recording feature will not operate.

3. Press the play (▶) button on the CD player.

The **main room source** changes on the receiver, and as soon as play starts, the cassette deck (or MD recorder) starts recording. When the play ends, the cassette deck (or MD recorder) enters recording pause, and stops about 4 seconds later.

Notes:

- During synchronized recording;
 - the selected main room source cannot be changed. (You can change the sub-room source.)
 - If the same source is selected both for the main room and the sub-room, operating the sub-room source will affect the recording.
- The **COMPU LINK** remote control system may not operate properly during synchronized recording;
 - If the power of any component is shut off.
 - If the main room sound is turned off by pressing **MAIN ROOM ON/OFF**.
 - In this case, you must start again from the beginning.

TEXT COMPU LINK Remote Control System

The TEXT COMPU LINK remote control system has been developed to deal with the disc information recorded in the CD Text* and MDs. Using this information in the discs, you can operate the CD player or MD recorder equipped with the TEXT COMPU LINK remote control system through the receiver.

The following operations are only possible while the receiver is ready for the main room operations, and are used for the main room sources.

CONNECTIONS:

To use this remote control system, you need to connect the CD player and/or MD recorder you want to operate, following the procedures below.

1. If you have already plugged your CD player, MD recorder, and this receiver into the AC outlets, unplug their AC power cords first.
2. Connect your CD player, MD recorder, and this receiver as follows, through the COMPU LINK jacks and TEXT COMPU LINK jacks.

- 1) **COMPU LINK jacks:** Use the cables with the monaural mini-plugs (not supplied with this receiver).

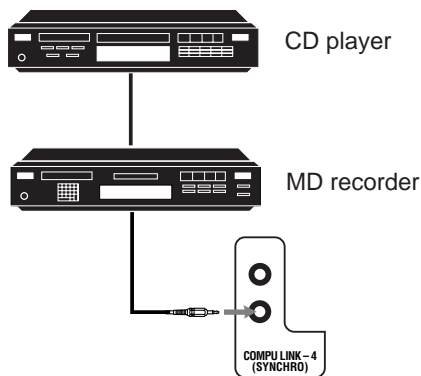

- 2) **TEXT COMPU LINK jacks:** Use the cables with the stereo mini-plugs (not supplied with this receiver).

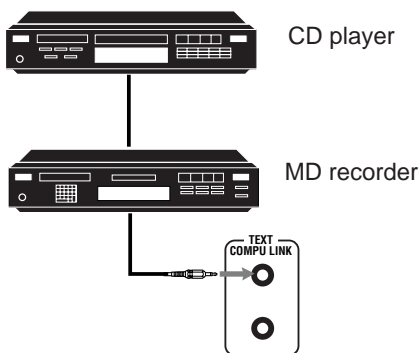

3. Connect your CD player, MD recorder and this receiver, using the cables with RCA pin plugs (see pages 7 and 8).
4. Plug the AC power cords of these components above into the AC outlets.
5. When turning on these components for the first time, turn on the connected components first, then turn on this receiver.

FUNCTIONS:

This remote control system allows you to use the functions listed below.

Displaying the Disc Information on the TV screen

Disc information such as its performer and disc title (and track titles only when a CD Text is selected) is shown on the TV screen.

Disc Search: Only for CD Player

This remote control system can allow you to search for discs by the performer, disc title, and music genre. With this disc search, you can easily find the disc you want to play.

Disc Title Input:

If your CD player or MD recorder has the disc memory function, you can input the following information about the normal audio CDs or MDs on the TV screen.

- For CDs: Performer, disc title, and music genre
- For MDs: Disc title and song titles

***What is a CD Text?**

In a CD Text, some information about the disc (its disc title, performer, composer, arranger, etc.) is recorded.

Notes:

- If your audio component has two COMPU LINK jacks, you can use either one. If it has only one COMPU LINK jack, connect it so that it is the last item in the series of components. (For example, the CD player in the diagram in the left column.)
- If your audio component has two TEXT COMPU LINK jacks, you can use either one. If it has only one TEXT COMPU LINK jack, connect it so that it is the last item in the series of components. (For example, the CD player in the diagram in the left column.)
- "TEXT COMPULINK SOURCE NOT CONNECTED" appears on the display in the following cases:
 - When the connections explained on the left are not correctly done.
 - When you try to use the TEXT COMPULINK function a few seconds after you turn on the connected equipment. This is not a malfunction of the units.
- Refer also to the manuals supplied with your CD player or MD recorder.

IMPORTANT:

If you turn on the receiver before turning on the other components after connecting the components, the TEXT COMPU LINK remote control system does not work correctly.

If this happens:

1. Turn off all the components including this receiver.
2. Turn on the connected components.
3. Turn on this receiver.

OPERATIONS:

To use this remote control system, you need to connect the TV to the MONITOR OUT jack on the rear panel (see page 9), and set the TV's input mode to the proper position to which the receiver is connected. **Make sure you have connected the CD player or MD recorder equipped with the TEXT COMPU LINK remote control system. If not, you cannot use the following functions.**

IMPORTANT:

Check to see if the proper indicator(s) and information appear on the display on the front panel before/while using the buttons and controls.

For the main room operations:

- The MAIN ROOM indicator is lit.
- The source name for the sub-room is not lit on the display.

When using the remote control:

- Set MAIN ROOM/SUB ROOM selector to “MAIN ROOM.”
- Check to see if the following information appear on the display window on the remote control.

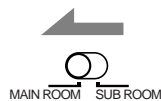

On-Screen Operation buttons (on the remote control)

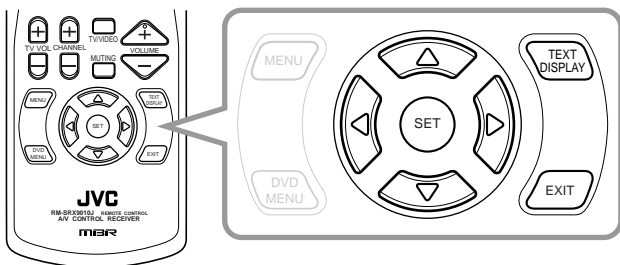

“MENU” appears on the display window of the remote control when you press the buttons — TEXT DISPLAY, Δ / ∇ / \triangleleft / \triangleright , SET, EXIT.

Ex. When you press TEXT DISPLAY, “MENU” appears on the display window.

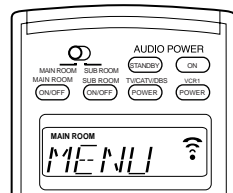

Showing the Disc Information on the TV Screen

Press TEXT DISPLAY while “CD” or “MD” is selected as the source.

The Disc Information screen appears on the TV.

Disc Information screen

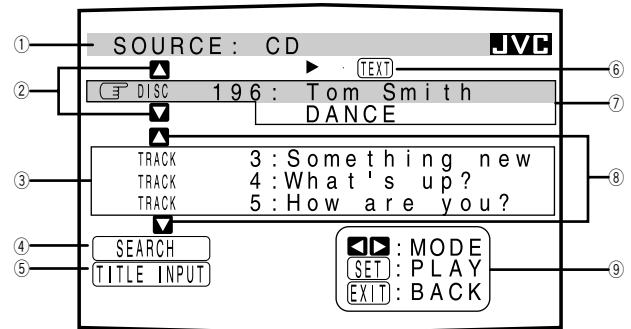

- ① Source name: CD or MD
- ② Select \triangleleft or \triangleright , then press SET to change the disc.
- ③ Track numbers and track titles.
 - When you move \triangleleft to a track number, you can change the track information by pressing \triangleleft / \triangleright . Each time you press the button, track information alternates between its track title and its performer. (You can also start playing the track by pressing SET.)
- ④ Select this (move \triangleleft in front), then press SET to go to the DISC SEARCH screen (see page 59).
- ⑤ Select this (move \triangleleft in front), then press SET to go to the TITLE INPUT screen (see page 60).
- ⑥ This appears only when a CD Text is selected.
- ⑦ Disc information such as the disc title, performer, and music genre.
 - When this is selected (\triangleleft in front), you can change the disc information by pressing \triangleleft / \triangleright . Each time you press the button, disc information (see “Note on ⑦”) changes.
- ⑧ Select \triangleleft or \triangleright , then press SET to change the track.
- ⑨ Usable buttons and their functions for the current selection.
 - Indication here will be changed according to what is currently selected (\triangleleft in front) on the screen. See “Note on ⑨.”

Note on ⑦:

The following information will appear on the display:

- For CD Texts — Disc title, Performer, Genre, Song writer, Composer, Arranger, Message
Only recorded information will be shown. If there is no data, “NO DATA” will appear.
- For MDs — Disc title
If there is no data, “NO DATA” will appear.

Note on ⑨:

For example, the SET button will be used to start play (PLAY), to go to the next screen (ENTER), and to determine the selection (ENTER).

To exit from the Disc information screen:

Press EXIT.

Notes:

- The on-screen display will disappear in the following cases:
 - if no operation is done for about 10 minutes.
 - if you do any operation other than explained in this section.
- To control the MD recorder using the TEXT COMPU LINK remote control system, you have to change the source name shown on the display from “TAPE” to “MD.” (See page 33.)
- Some special characters and marks cannot be displayed correctly.

■ Searching for a Disc (Only for the CD player)

Search for a disc by its performer:

1. Press TEXT DISPLAY while “CD” is selected as the source.
The Disc Information screen appears on the TV.
2. Press Δ / ∇ to move \leftarrow to “SEARCH,” then press SET.
The DISC SEARCH screen appears.

3. Press Δ / ∇ to move \leftarrow to “PERFORMER,” then press SET.
The PERFORMER SEARCH screen appears.

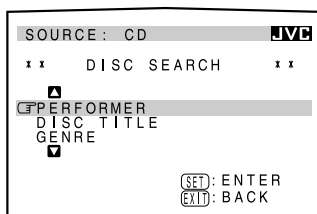

4. Press $\Delta / \nabla / \triangleleft / \triangleright$ to move \leftarrow in front of the first character of the performer you want to search for, then press SET.

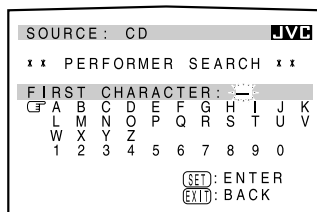

To correct the incorrect entry, press $\Delta / \nabla / \triangleleft / \triangleright$ to move \leftarrow in front of the correct character, then press SET.

Note:

Symbols such as @, # or \$ cannot be available for search.

5. Press SET again.
Disc search starts, then the SEARCH RESULT screen, showing the performers, appears.

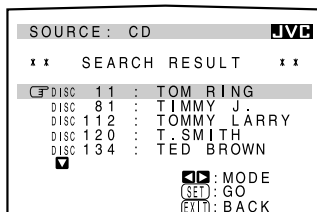

6. On the SEARCH RESULT screen, you can do the following:

- **Changing the indication of the disc information:**
Press Δ / ∇ to move \leftarrow to a searched for disc, then press $\triangleleft / \triangleright$. Each time you press $\triangleleft / \triangleright$, the disc information alternates between its performer and its disc title.
- **Starting a disc play and going to the Disc Information screen (see page 58):** Press Δ / ∇ to move \leftarrow to a searched for disc, then press SET.
- **Showing unseen disc information (if more than 5 discs are listed as a result of the search):** Press Δ / ∇ until they appear.
- **Going back to the PERFORMER SEARCH screen:** Press EXIT.

Search for a disc by its disc title:

1. Press TEXT DISPLAY while “CD” is selected as the source.
The Disc Information screen appears on the TV.
2. Press Δ / ∇ to move \leftarrow to “SEARCH,” then press SET.
The DISC SEARCH screen appears.
3. Press Δ / ∇ to move \leftarrow to “DISC TITLE,” then press SET.
The DISC TITLE SEARCH screen appears.

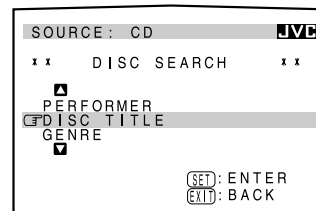

4. Press $\Delta / \nabla / \triangleleft / \triangleright$ to move \leftarrow in front of the first character of the disc title you want to search for, then press SET.

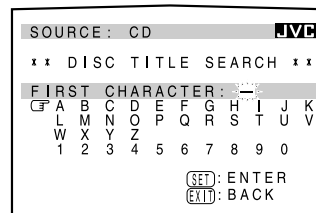

To correct the incorrect entry, press $\Delta / \nabla / \triangleleft / \triangleright$ to move \leftarrow in front of the correct character, then press SET.

Note:

Symbols such as @, # or \$ cannot be available for search.

5. Press SET again.
Disc search starts, then the SEARCH RESULT screen, showing the disc titles, appears.

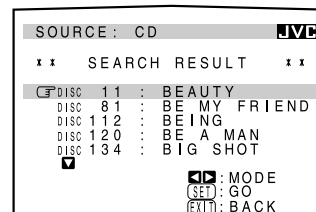

6. On the SEARCH RESULT screen, you can do the following:

- **Changing the indication of the disc information:**
Press Δ / ∇ to move \leftarrow to a searched for disc, then press $\triangleleft / \triangleright$. Each time you press $\triangleleft / \triangleright$, the disc information alternates between its disc title and its performer.
- **Starting a disc play and going to the Disc Information screen (see page 58):** Press Δ / ∇ to move \leftarrow to a searched for disc, then press SET.
- **Showing unseen disc information (if more than 5 discs are listed as a result of the search):** Press Δ / ∇ until they appear.
- **Going back to the DISC TITLE SEARCH screen:** Press EXIT.

Search for a disc by its genre:

1. Press TEXT DISPLAY while “CD” is selected as the source.

The Disc Information screen appears on the TV.

2. Press Δ / ∇ to move \leftarrow to “SEARCH,” then press SET.

The DISC SEARCH screen appears.

3. Press Δ / ∇ to move \leftarrow to “GENRE,” then press SET.

The GENRE SEARCH screen appears.

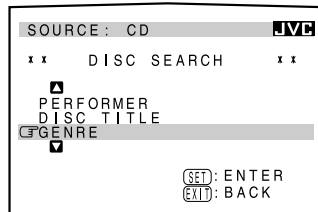

4. Press Δ / ∇ to move \leftarrow to the genre you want to search for, then press SET.

To show the unseen genres, press Δ / ∇ until they appear.

Disc search starts, then the SEARCH RESULT screen, showing the disc titles, appears.

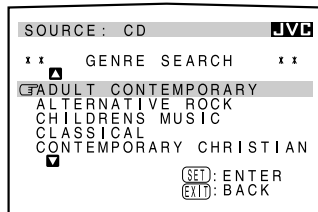

5. On the SEARCH RESULT screen, you can do the following:

- **Changing the indication of the disc information:**

Press Δ / ∇ to move \leftarrow to a searched for disc, then press

$\triangleleft / \triangleright$. Each time you press $\triangleleft / \triangleright$, the disc information alternates between its disc title and its performer.

- **Starting a disc play and going to the Disc Information screen (see page 58):** Press Δ / ∇ to move \leftarrow to a searched for disc, then press SET.

- **Showing unseen disc information (if more than 5 discs are listed as a result of the search):** Press Δ / ∇ until they appear.

- **Going back to the GENRE SEARCH screen:** Press EXIT.

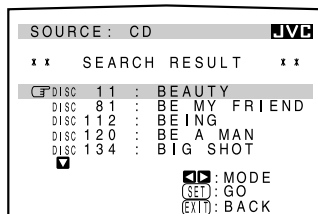

Entering the Disc Information

For the CD Player with the disc memory function:

You can use the disc memory function through this receiver.

The disc information (its performer, disc title, and music genre) of normal audio CDs will be stored into the memory built in the CD player.

For the disc memory function, refer to the manual supplied with your CD player.

- The performer, disc title, and music genre information are usually recorded on a CD Text. However, if a CD Text has no genre information recorded on the disc itself, you can input its music genre by yourself.

Note:

You can enter the TITLE INPUT screens for a CD Text and input its titles. However, you cannot store the titles you have input for a CD Text.

Example: Entering the following information for Disc 1
Performer: “MICHAEL”
Disc title: “MY FAVORITE”

1. Press TEXT DISPLAY while “CD” is selected as the source.

The Disc Information screen appears on the TV.

2. Press Δ / ∇ to move \leftarrow to “TITLE INPUT,” then press SET.

The TITLE INPUT:

PERFORMER screen appears.

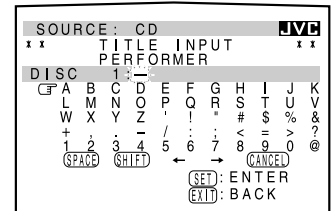

3. Press $\Delta / \nabla / \triangleleft / \triangleright$ to move \leftarrow in front of a character you want, then press SET to enter the character.

- If the current CD is a CD Text, go to step 5 without entering the performer.

To use the lower-case letters, press $\Delta / \nabla / \triangleleft / \triangleright$ to move \leftarrow to (SHIFT), then press SET.

To use the upper-case letters again, press $\Delta / \nabla / \triangleleft / \triangleright$ to move \leftarrow to (SHIFT), then press SET.

Continued to the next page.

4. Repeat step 3 until you finish putting a performer name (up to 32 characters).

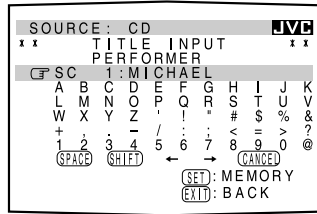

To insert a space, press $\Delta / \nabla / \triangleleft / \triangleright$ to move C to SPACE , then press SET.

To correct an incorrect character:

- 1) Press $\Delta / \nabla / \triangleleft / \triangleright$ to move C to \leftarrow or \rightarrow , then press SET until the incorrect character is selected.
- 2) Press $\Delta / \nabla / \triangleleft / \triangleright$ to move C to CANCEL , then press SET to erase the character.
- 3) Press $\Delta / \nabla / \triangleleft / \triangleright$ to move C in front of the correct character, then press SET to enter the correct character.

5. Press $\Delta / \nabla / \triangleleft / \triangleright$ to move C to "DISC 1: MICHAEL (in this example)," then press SET.

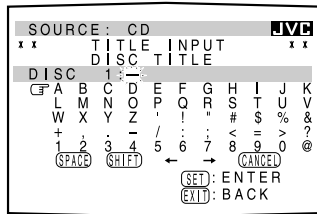

The TITLE INPUT: DISC TITLE screen appears.

6. Enter the disc title, referring to steps 3 and 4.

- If the current CD is a CD Text, go to the next step without entering the disc title.

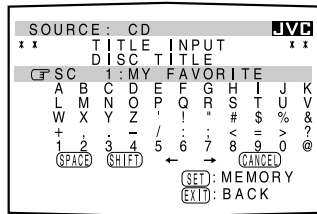

7. Press $\Delta / \nabla / \triangleleft / \triangleright$ to move C to "DISC 1: MY FAVORITE (in this example)," then press SET.

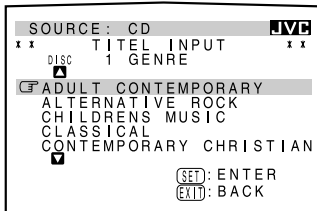

The TITLE INPUT: DISC 1 GENRE screen appears.

8. Press Δ / ∇ to move C to the genre you want, then press SET.

The Disc Information screen appears again.

To show the unseen genres, press Δ / ∇ until they appear.

For the MD recorder:

You can write the disc information (disc title and song titles) into the disc. You can only write the song title for the song currently selected.

- If you have the CD-MD combination deck, you can also enter the disc information (its performer, disc title, and its music genre) of normal audio CDs into the memory built in the CD-MD combination deck. (To do this, follow the procedure of "For the CD Player with the disc memory function" on page 60.)
- If you change the disc or song title including more than 32 characters, the characters following 32nd will be erased from the title.

1. Press TEXT DISPLAY while "MD" is selected as the source.

The Disc Information screen appears on the TV.

2. Press Δ / ∇ to move C to "TITLE INPUT," then press SET.

The DISC TITLE INPUT screen appears.

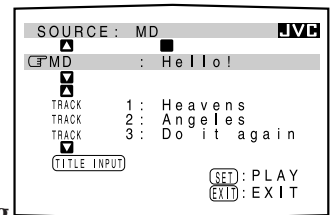

3. Enter the title, referring to steps 3 and 4 of "For the CD Player with the disc memory function" on pages 60 and 61.

- You can enter up to 32 characters for the disc title.

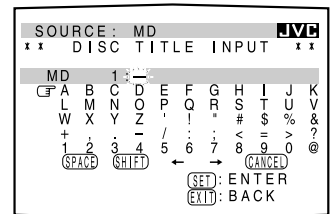

4. Press $\Delta / \nabla / \triangleleft / \triangleright$ to move C to the disc title you have just entered, then press SET.

The disc title is stored into the memory, and the SONG TITLE INPUT screen for the currently selected song appears.

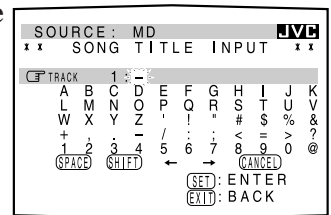

- You can enter a song title for the song currently selected.

5. Enter the song title, referring to steps 3 and 4 of "For the CD Player with the disc memory function" on pages 60 and 61.

- You can enter up to 32 characters for the song title.

6. Press $\Delta / \nabla / \triangleleft / \triangleright$ to move C to the song title you have just entered, then press SET.

The song title is stored into the memory, and the Disc Information screen appears again.

AV COMPU LINK Remote Control System

This receiver is equipped with the AV COMPU LINK-III. The AV COMPU LINK remote control system allows you to operate JVC video components (TV, VCR, and DVD player) through the receiver. To use this remote control system, you need to connect the video components you want to operate, following the procedure below.

1. If you have already plugged your VCR 1 (VCR connected to the VCR 1 jacks), DVD player, TV, and this receiver into the AC outlets, unplug their AC power cords first.
2. Connect the IR signal transmitter (supplied) to the IR OUT on the rear, and place it so that it is aimed at the remote sensor on the target video components.
 - See "CONNECTIONS 1" below.
3. Connect your VCR 1, DVD player, TV, and this receiver as follows, using the cables with the monaural mini-plugs (not supplied).
 - See "CONNECTIONS 2" below.
4. Connect the audio input/output jacks on VCR 1, DVD player, TV, and this receiver using the cables with RCA pin plug.
 - See pages 8 and 9.
5. Connect the video input/output jacks on VCR 1, DVD player, TV, and this receiver, using the cables with RCA pin plugs, with S-video plugs or with component video plugs.
 - See "CONNECTIONS 3" on the next page.
6. Plug the AC power cords of the components into the AC outlets.
7. When turning on the TV for the first time after the AV COMPU LINK connection, turn the TV volume to the minimum using the TV volume control on the TV.
8. Turn on the other connected components first, then turn on this receiver.
 - When turning on the VCR 1, use the remote control supplied with this receiver (press VCR 1 POWER).

CONNECTIONS 1: IR Signal Transmitter Connection

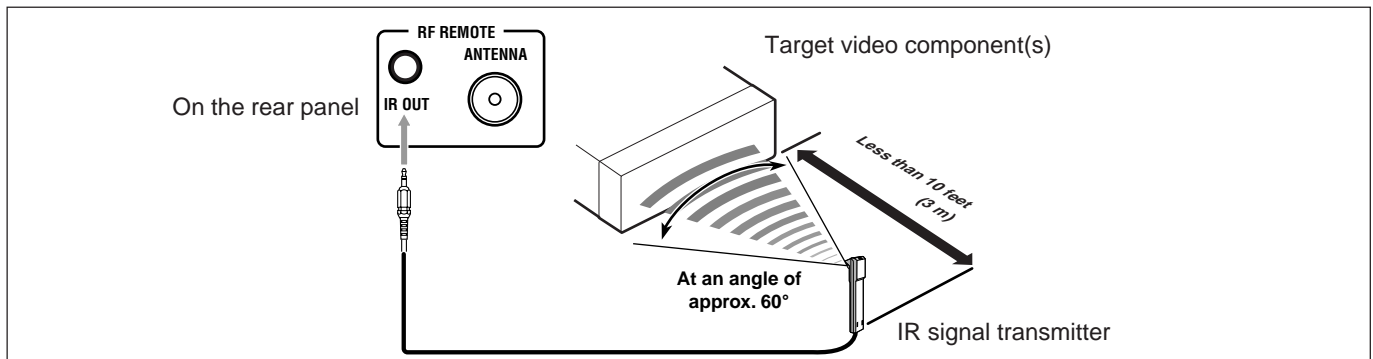

CONNECTIONS 2: AV COMP LINK Connection

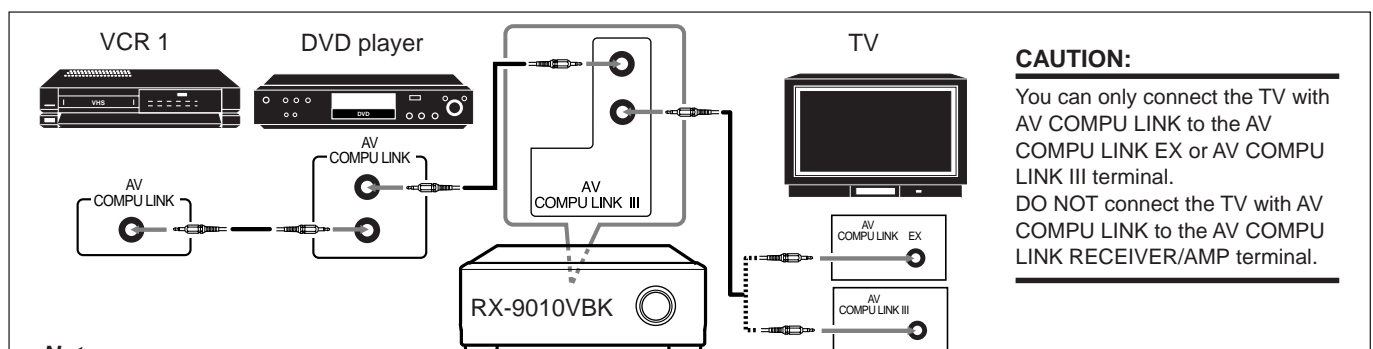

CAUTION:

You can only connect the TV with AV COMPU LINK to the AV COMPU LINK EX or AV COMPU LINK III terminal.
DO NOT connect the TV with AV COMPU LINK to the AV COMPU LINK RECEIVER/AMP terminal.

Notes:

- The AV COMPU LINK remote control system cannot control the DBS tuner connected to the TV SOUND/DBS and DBS component video terminals, and video components connected to the VIDEO and VCR 2 terminals on the receiver.
- When connecting only the VCR 1 and DVD player to this receiver, connect it directly to the receiver using cable with the monaural mini-plugs.
- When connecting the receiver and the TV with AV COMPU LINK EX terminal by using the component video cables, you cannot use Automatic Selection of TV's Input Mode (see page 64).
- Refer also to the manual supplied with your video components.

CONNECTIONS 3: Video Cable Connection

This receiver is equipped with three types of the video terminals — S-video, composite video, or component video, and the signals coming into this receiver through one type of video terminals can output only through the same type of the terminal. So you need to connect the VCR and/or DVD player to the TV using one of the following three ways:

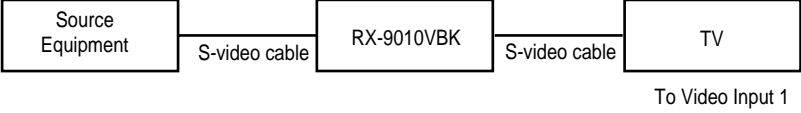
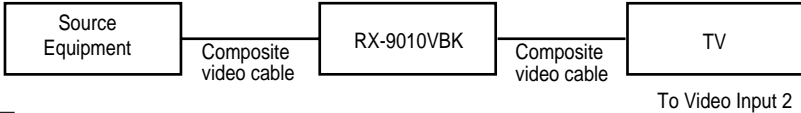
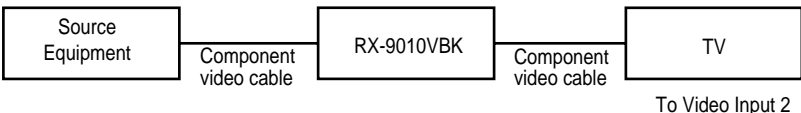
CASE 1	<p>When connecting the source equipment to the receiver using the S-video terminals, connect also this receiver to the TVs' Video Input 1 terminal using S-video cables.</p>  <p>Note: If you connect the DVD player and the DBS tuner to this receiver using the composite video terminals, change the video input terminal setting to "S/C" (see page 32).</p>
CASE 2	<p>When connecting the source equipment to the receiver using the composite video terminals, connect also this receiver to the TVs' Video Input 2 terminal (composite video input) using composite video cables.</p>  <p>Note: If you connect the DVD player and the DBS tuner to this receiver using the S-video terminals, change the video input terminal setting to "S/C" (see page 32).</p>
CASE 3	<p>When connecting the source equipment to the receiver using the component video terminals, connect also this receiver to the TVs' Video Input terminals (component video input) using component video cables.</p>  <p>Note: If you connect the DVD player and the DBS tuner to this receiver using the video component terminals, change the video input terminal setting to "COMPNT" (see page 32).</p>

The AV COMPU LINK remote control system allows you to use the five basic functions listed below.

Remote Control of the TV, DVD player, and VCR Using This Remote Control

IMPORTANT:

To operate the video components using the IR signal transmitter (supplied), place it so that it is aimed at the remote sensor on the target video component(s).

- The IR signal transmitter can send signals at a distance of 10 feet (3 m).

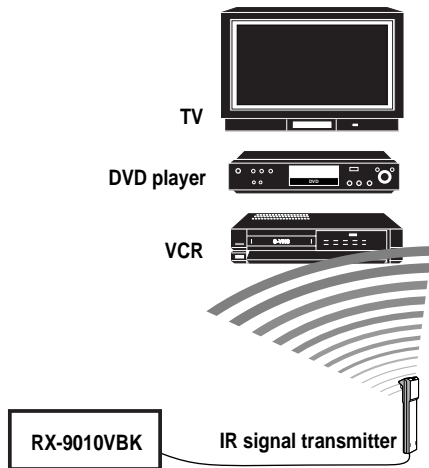

You can control the connected video components using this remote control: Aim the remote control at the remote sensors on the target video component(s) or on the receiver directly. For details, see page 62.

One-Touch Video Play

- Simply by inserting a video cassette without its safety tab into the VCR 1 (the VCR connected to the VCR 1 jacks), you can enjoy the video playback without setting other switches manually. The receiver automatically turns on and changes the **main room source** to "VCR 1." The TV automatically turns on and changes the input mode to the position so that you can view the playback picture. When you insert a video cassette with its safety tab, press the play (▶) button on the VCR 1 or on its remote control. So, you can get the same result.
 - If the receiver is already turned on, and the SUB ROOM indicator and the source name for the sub-room are lit on the display, the receiver changes the **sub-room source** to "VCR 1." (In this case, the TV will not turn on automatically.)
- When you press PLAY on the remote control supplied with this receiver for operating the VCR 1, the receiver automatically turns on and changes the **main room source** or **sub-room source** (depending on MAIN ROOM/SUB ROOM selector setting on the remote control) to "VCR 1."
 - For main room operations only: The TV automatically turns on and changes the input mode to the position so that you can view the playback picture.

One-Touch DVD Play

Simply by starting playback on the DVD player, you can enjoy the DVD playback without setting other switches manually.

When you press PLAY on the remote control supplied with this receiver for operating the DVD player, the receiver automatically turns on and changes the **main room source** or **sub-room source** (depending on MAIN ROOM/SUB ROOM selector setting on the remote control) to the appropriate input — “DVD,” or “DVD MULTI” as the main room source, and “DVD” as the sub-room source.

The TV automatically turns on (for main room operations only) and changes the input mode to the position so that you can view the playback picture.

- *When the DVD player is connected through the analog input jacks on this receiver (and analog input is selected), the receiver automatically turns on and changes the source to “DVD” or “DVD MULTI.”*
 - If the receiver is already turned on, and the SUB ROOM indicator and the source name for sub-room are lit on the display, the receiver changes the **sub-room source** to “DVD.” In this case, the TV will not turn on automatically.
- *When the DVD player is connected through the digital input terminal on this receiver (and digital input is selected), the receiver automatically turns on and changes the main room source to “DVD.”*
 - If the receiver is already turned on and the SUB ROOM indicator and the source name for sub-room are lit on the display, no sound comes out.

Automatic Selection of TV's Input Mode (Only for the Main Room Operations)

- When you select “TV” as the **main room source** to play on the receiver, the TV automatically changes the input mode to the TV tuner so that you can watch TV.
- When you select “DVD,” “DVD MULTI,” “VCR 1,” “VCR 2,” “VIDEO” or “DBS” as the **main room source** to play on the receiver, the TV automatically changes the input mode to the appropriate position (either Video Input 1 or Video Input 2) so that you can view the playback picture.

Notes:

- *When you select “TV” as the source on the receiver, you cannot see the menu on the TV screen since the AV COMPU LINK remote control system automatically changes the TV's input mode to the TV tuner.*
If you do not mind stopping listening to the TV sounds, you can then show the on-screen displays after changing the TV's input mode to the appropriate position (either Video Input 1 or Video Input 2) the receiver is connected to.
- *This function does not work when you connect the TV with the AV COMPU LINK to the AV COMPU LINK EX. In this case, reconnect the TV referring to case 1 or case 2 on page 63.*

Automatic Power On/Off (Standby)

Automatic Power On:

The TV, VCR 1 (the VCR connected to the VCR 1 jacks), and DVD player turn on and off along with the receiver.

- **When you turn on the receiver by pressing POWER on the front panel or AUDIO POWER ON on the remote control (with MAIN ROOM/SUB ROOM selector set to “MAIN ROOM”):**

OR

When you turn on the main room sound by pressing MAIN ROOM ON/OFF while the receiver is turned on:

The MAIN ROOM indicator and the source name for the main room light up on the display, and —

- If the previously selected **main room source** is “VCR 1,” the TV and VCR 1 will turn on automatically.
- If the previously selected **main room source** is “DVD,” or “DVD MULTI,” the TV and DVD player will turn on automatically.
- If the previously selected **main room source** is “VIDEO,” “VCR 2,” “TV” or “DBS,” only the TV will turn on automatically.

- **When you turn on the receiver by pressing AUDIO POWER ON on the remote control (with MAIN ROOM/SUB ROOM selector set to “SUB ROOM”):**

OR

When you turn on the sub-room sound by pressing SUB ROOM ON/OFF while the receiver is turned on:

The SUB ROOM indicator and the source name for the sub-room light up on the display, and —

- If the previously selected **sub-room source** is “VCR 1,” the VCR 1 will turn on automatically.
- If the previously selected **sub-room source** is “DVD,” the DVD player will turn on automatically.
- If the previously selected **sub-room source** is “VIDEO,” “VCR 2,” or “DBS,” nothing happens.

Automatic Power Off (Standby):

- **When you turn off the receiver by pressing POWER,** the TV, VCR 1 and the DVD player will turn off (standby).
- **When you turn off the main room sound by pressing MAIN ROOM ON/OFF,** the selected **main room source** component turns off (unless the same component is selected as the sub-room source), and the TV also turns off.
 - If the SUB ROOM indicator and the source name for the sub-room are lit on the display, nothing happens.
- **When you turn off the sub-room sound by pressing SUB ROOM ON/OFF,** the selected **sub-room source** component turns off (unless the same component is selected as the main room source).
 - If the MAIN ROOM indicator and the source name for the main room are lit on the display, nothing happens.

Note:

If you turn off the receiver by pressing POWER or turn off the main room sound by pressing MAIN ROOM ON/OFF while recording on the VCR 1, the VCR 1 will not turn off, but continue recording.

Operating JVC's Audio/Video Components

You can operate JVC's audio and video components with this receiver's remote control, since control signals for JVC components are preset in the remote control.

Operating Audio Components

IMPORTANT:

To operate JVC's audio components using this remote control:

- You need to connect JVC audio components through the COMPU LINK-4 (SYNCHRO) jacks (see page 55) in addition to the connections using cables with RCA pin plugs (see pages 7 and 8).
- Aim the remote control directly at the remote sensor on the receiver.
- If you use the buttons on the front panel or the menu function to choose a source, the remote control will not operate that source. To operate a source with the remote control, the source must be selected using source selecting buttons on the remote control.
- To operate the cassette deck or MD recorder using the COMPU LINK remote control system, set the source name correctly. (See page 33.)
- Refer also to the manuals supplied with your components.

When using the remote control supplied with this receiver:

- For the main room operations**
 - Set MAIN ROOM/SUB ROOM selector to "MAIN ROOM."
- For the sub-room operations**
 - Set MAIN ROOM/SUB ROOM selector to "SUB ROOM."
 - Check to see if the following information appear on the display window on the remote control:

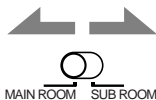

MAIN ROOM/ SUB ROOM selector	Indications
MAIN ROOM	MAIN ROOM *
SUB ROOM	SUB ROOM *

* MAIN ROOM or SUB ROOM indicator does not appear when no indicators appear on the display window.

Buttons	Indications
FM/AM	TUNER
CD	CD
CDR	CDR
PHONO	PHONO
TAPE/MD	TAPE
CONTROL (repeatedly)	VCRI → TAPE → CDR → CDDSC → (back to the beginning)
SOUND	SOUND

After selecting a source:

Buttons	Indications
PLAY	one of the selected source names listed above
◀◀/REW	
FF/▶▶	
STOP	
PAUSE	
1 - 10, +10, 0	

After pressing SOUND, the following function are assigned to the specific number buttons:

Buttons	Indications
BALANCE L	SOUND
BALANCE R	
EFFECT	
ROOM SIZE	
LIVENESS	
CENTER TONE	
SUBWFR	S WFR
CENTER	CTR
REAR•L	REARL
REAR•R	REARR
DIGITAL EQ	EQ

When you press the buttons listed above, the indication appears for 5 - 10 seconds for your confirmation.

Tuner



You can always perform the following operations:

FM/AM: Alternates between FM and AM.

After pressing FM/AM, you can perform the following operations:

1 - 10, +10: Selects a preset channel number directly.
For channel number 5, press 5.
For channel number 15, press +10, then 5.
For channel number 20, press +10, then 10.

TUNING UP/DOWN: Tunes into stations.

FM MODE: Changes the FM reception mode.

Sound control section (Amplifier)

You can always perform the following operations:

SURROUND ON/OFF: Turns on or off the Surround modes — Dolby Pro Logic, Dolby Digital, and DTS Digital Surround.

DSP MODE: Selects the DSP modes.

TEST: Turns on or off the test tone output.

After pressing SOUND, you can perform the following operations:

SUBWFR then LEVEL +/-: Adjusts the subwoofer output level.

CENTER then LEVEL +/-: Adjusts the center speaker output level.

REAR•L then LEVEL +/-: Adjusts the left rear speaker output level.

REAR•R then LEVEL +/-: Adjusts the right rear speaker output level.

DIGITAL EQ then LEVEL +/-: Selects the audio band and adjusts its frequency level.

BALANCE L/BALANCE R: Adjusts the output balance of the front speakers.

EFFECT: Selects the effect level.

CENTER TONE: Selects the center tone.

ROOM SIZE: Selects the room size.

LIVENESS: Selects the liveness.

Notes:

- After adjusting sounds, press the corresponding source selecting button to operate your target source by using the 10 keys; otherwise, the 10 keys cannot be used for operating your target source.
- Each time you press LEVEL + or LEVEL -, the indication corresponding to the function you have selected appears on the display window on the remote control.

CD player



After pressing CD, you can perform the following operations on the CD player:

PLAY: Starts playing.

◀◀: Returns to the beginning of the current (or previous) track.

▶▶: Skips to the beginning of the next track.

STOP: Stops playing.

PAUSE: Pauses playing. To release it, press PLAY.

1 - 10, +10: Selects a track number directly.

For track number 5, press 5.

For track number 15, press +10, then 5.

For track number 20, press +10, then 10.

For track number 30, press +10, +10, then 10.

CD player-changer



After selecting CDDSC by pressing CONTROL repeatedly, you can perform the following operations on a CD player-changer:

- PLAY: Starts playing.
◀◀: Returns to the beginning of the current (or previous) track.
▶▶: Skips to the beginning of the next track.
STOP: Stops playing.
PAUSE: Pauses playing. To release it, press PLAY.
1 – 6, 7/P: Selects the number of a disc installed in a CD player-changer.

After pressing CD, you can perform the following operations on the CD player-changer:

- 1 – 10, +10: Selects a track number directly.
For track number 5, press 5.
For track number 15, press +10, then 5.
For track number 20, press +10, then 10.
For track number 30, press +10, +10, then 10.

EXAMPLE:

- Selecting disc number 4, track number 12, and starting playback.
 1. Press CONTROL repeatedly until “CDDSC” appears on the display window, then press 4.
 2. Press CD, then press +10, 2.

If your CD changer is of 200-disc loading capability (except for XL-MC100 and XL-MC301)

you can do the following operations using the number buttons after pressing CD.

1. Select a disc number.
2. Then select a track number (always enter two digits).
3. Start playback.

EXAMPLES:

- Selecting disc number 3, track number 2, and starting playback. Press 3, then, 0, 2, then PLAY.
- Selecting disc number 10, track number 5, and starting playback. Press 1, 0, then, 0, 5, then PLAY.
- Selecting disc number 105, track number 12, and starting playback. Press 1, 0, 5, then 1, 2 then PLAY.

CD recorder



After pressing CDR, you can perform the following operations on a CD recorder:

- PLAY: Starts playing.
◀◀: Returns to the beginning of the current (or previous) track.
▶▶: Skips to the beginning of the next track.
STOP: Stops playing.
PAUSE: Pauses playing. To release it, press PLAY.
1 – 10, +10: Selects a track number directly.
For track number 5, press 5.
For track number 15, press +10, then 5.
For track number 20, press +10, then 10.
For track number 30, press +10, +10, then 10.

Notes:

- When you start recording on the CD recorder, use the buttons on the CD recorder itself or on the remote control supplied with it.
- You can use either CDR or CONTROL to activate the buttons listed above. If you press CDR, the playing source also changes. On the other hand, if you press CONTROL repeatedly to select “CDR,” the playing source does not change.

Turntable



After pressing PHONO, you can perform the following operations on a turntable:

- PLAY: Starts playing.
STOP: Stops operations.

Cassette deck



After pressing TAPE/MD or selecting “TAPE” by pressing CONTROL repeatedly, you can perform the following operations on a cassette deck:

- PLAY: Starts playing.
REW: Fast-winds the tape from right to left.
FF: Fast-winds the tape from left to right.
STOP: Stops operations.
PAUSE: Pauses playing. To release it, press PLAY.
● REC: Press this button with the PLAY button to start recording (for the main room operation only). Press this button with the PAUSE button to enter recording pause.

Notes:

- When you use a cassette deck or MD recorder, change the source name connected to TAPE/MD terminals correctly (see page 33).
- You can use either TAPE/MD or CONTROL to activate the buttons listed above. If you press TAPE/MD, the playing source also changes. On the other hand, if you press CONTROL repeatedly to select “TAPE”, the playing source does not change.

MD recorder



After pressing TAPE/MD, you can perform the following operations on the MD recorder:

- PLAY: Starts playing.
◀◀: Returns to the beginning of the current (or previous) track.
▶▶: Skips to the beginning of the next track.
STOP: Stops playing.
PAUSE: Pauses playing. To release it, press PLAY.
● REC: Press this button with the PLAY button to start recording (for the main room operation only). Press this button with the PAUSE button to enter recording pause.

Note:

When you use a cassette deck or MD recorder, change the source name connected to TAPE/MD terminals correctly (see page 33).

Operating Video Components

IMPORTANT:

To operate JVC's video components using this remote control:

- You need to connect JVC video components through the AV COMPU LINK jacks (see page 62) in addition to the connections using cables with RCA pin plugs (see pages 8 and 9).
- Some JVC VCRs can accept two types of the control signals — remote codes "A" and "B." Before using this remote control, make sure that the remote control code of the VCR connected to the VCR 1 terminals is set to code "A."
 - When another JVC VCR is connected to the VCR 2 and VIDEO jacks, set its remote control code to code "B." (This remote control cannot emit the control signals of code "B.")
- To operate the video component(s) using the remote control:
 - Aim the remote control directly at the remote sensor on each component, not on the receiver.
- To operate the video component(s) using the RF signals emitted from this remote control, the IR signal transmitter and the RF rod antenna must be connected to this receiver.
 - Place the IR signal transmitter so that it is aimed at the remote sensor on the target video component(s).
 - The RF signal-reachable distance may differ depending on the operating conditions and circumstances.
 - The IR signal transmitter can send signals at a distance of 10 feet (3 m).

When using the remote control:

Check to see if MAIN ROOM/SUB ROOM selector and TV/CATV/DBS selector are set to the correct positions:

TV/CATV/DBS selector:

To operate TVs, set it to "TV."

MAIN ROOM/SUB ROOM selector:

For the main room operations

Set MAIN ROOM/SUB ROOM selector to "MAIN ROOM."

For the sub-room operations

Set MAIN ROOM/SUB ROOM selector to "SUB ROOM."

Check to see if the following information appear on the display window on the remote control:

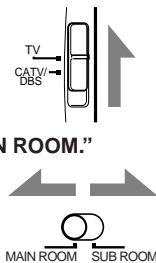

MAIN ROOM/ SUB ROOM selector	Indications
MAIN ROOM	MAIN ROOM *
SUB ROOM	SUB ROOM *

* MAIN ROOM or SUB ROOM indicator does not appear when no indicators appear on the display window.

Buttons	Indications
VCR 1	VCR 1
DVD or DVD MULTI	DVD
TV/DBS	TV
CONTROL (repeatedly)	VCR1 → TAPE → CDR → CDDSC → (back to the beginning)
DVD MENU	DMENU

After selecting a source:

Buttons	Indications
PLAY	one of the selected source names listed above
◀◀/REW	
FF/▶▶	
STOP	
PAUSE	
1 - 9, 0, +10, 100+	VCR1 or TV
CHANNEL +/-	

After pressing DVD MENU:

Buttons	Indications
△, ▽, <, >, SET	DMENU

When you press the buttons listed above, the corresponding indication appears for 5 - 10 seconds for your confirmation.

VCR (VCR connected to the VCR 1 jacks)



You can always perform the following operations:

VCR 1 POWER: Turns on or off the VCR 1.

After pressing VCR 1 or selecting "VCR" by pressing CONTROL repeatedly, you can perform the following operations on a VCR:

- 1 - 9, 0: Selects the TV channels on a VCR.
- PLAY: Starts playing.
- REW: Rewinds a tape.
- FF: Fast winds a tape.
- STOP: Stops operations.
- PAUSE: Pauses playing. To release it, press PLAY.
- REC: Press this button with the PLAY button to start recording (only for the main room operations). Press this button with the PAUSE button to enter recording pause.
- CHANNEL +/-: Changes the TV channels on a VCR.

Note:

You can use either VCR 1 button or CONTROL to activate the buttons listed above. If you press VCR 1, the playing source also changes. On the other hand, if you press CONTROL repeatedly to select "VCR1," the playing source does not change.

DVD player



After pressing DVD (or DVD MULTI: only for the main room operations), you can perform the following operations on a DVD player:

- 1 - 10, 0, +10: Selects the DVD titles or the tracks.
- PLAY: Starts playing.
- ◀◀: Returns to the beginning of the current (or previous) track.
- ▶▶: Skips to the beginning of the next track.
- STOP: Stops playing.
- PAUSE: Stops playing temporarily. To release it, press PLAY.

After pressing DVD MENU (only for the main room operations), these buttons can be used for the DVD menu operations.

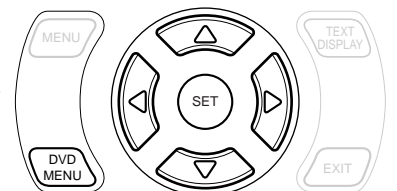

Note:

For detailed menu operations, refer to the instructions supplied with the discs or the DVD player.

TV

You can always perform the following operations (with TV/CATV/DBS selector set to "TV"):

- TV/CATV/DBS POWER: Turns on or off the TV.
- TV VOL +/-: Adjusts the volume.
- TV/VIDEO: Sets the input mode (either TV or VIDEO).

After pressing TV/DBS (with TV/CATV/DBS selector set to "TV"), you can perform the following operations on a TV:

- CHANNEL +/-: Changes the channels.
- 1 - 9, 0, 100+: Selects the channels.
- RETURN: Alternates between the previously selected channel and the current channel.

Operating Other Manufacturers' Equipment

This remote control supplied with the receiver can transmit control signals for other manufacturers' VCRs, TVs, CATV converters, DBS tuners, DVD players, and CD players. By changing the transmittable signals from preset ones to the other manufacturers', you can operate the other manufacturer's components using this remote control.

When operating the other manufacturers' components, refer also to the manuals supplied with them. To operate these components with the remote control, first you need to set the manufacturer's code each for VCR, TV, CATV converter, DBS tuner, and DVD player.

After replacing batteries of the remote control, set the manufactures' codes again.

IMPORTANT:

- To operate the video component(s) using the RF signals emitted from this remote control, the IR signal transmitter and the RF rod antenna must be connected to this receiver.
 - Place the IR signal transmitter so that it is aimed at the remote sensor on the target video component(s).
 - The RF signal-reachable distance may differ depending on the operating conditions and circumstances.
 - The IR signal transmitter can send signals at a distance of 10 feet (3 m).

When using the remote control:

Check to see if TV/CATV/DBS selector are set to the correct position:

TV/CATV/DBS selector:

- For TV operations**
Set TV/CATV/DBS selector to "TV."
- For the CATV converter and DBS tuner operations**
Set TV/CATV/DBS selector to "CATV/DBS."
- Check to see if the following information appear on the display window on the remote control.

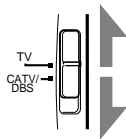

After setting the remote control mode selector to "TV" :

Buttons	Indications
TV/DBS	TV
VCR 1	VCR 1
DVD or DVD MULTI	DVD
CD	CD
DVD MENU	DMENU

After setting the remote control mode selector to "CATV/DBS" :

Buttons	Indications
TV/DBS	CATV
VCR 1	VCR 1
DVD or DVD MULTI	DVD
CD	CD
DVD MENU	DMENU

After selecting a source:

Buttons	Indications
PLAY	one of the source names listed above
◀▶	
▶▶	
STOP	
PAUSE	
1 - 9, 0, +10, 100+	VCR1 or TV
CHANNEL +/-	

After pressing DVD MENU:

Buttons	Indications
△, ▽, ◀, ▶, SET	DMENU

When you press the buttons listed above, the indication appears for 5 - 10 seconds for your confirmation.

Note:

All the functions may not be assigned to the buttons in some equipment.

To change the transmittable signals for operating another manufacturer's TV

- Set TV/CATV/DBS selector to "TV."
- Press and hold TV/CATV/DBS POWER.
- Press TV/DBS.
- Enter manufacturer's code using buttons 1-9, and 0.
- Release TV/CATV/DBS POWER.

See page 70 to find the code.

After setting TV/CATV/DBS selector to "TV," you can perform the following operations on the TV:

TV/CATV/DBS POWER: Turns on and off the TV.
 TV VOL +/-: Adjusts the volume.
 TV/VIDEO: Sets the input mode (either TV or VIDEO).

After pressing TV/DBS (with the remote control mode selector set to "TV"), you can perform the following operations on a TV:

CHANNEL +/-: Changes the channels.
 1 - 10, 0, 100+ (+10): Selects the channels.
 The 10 button will function as the ENTER button if your TV requires pressing ENTER after selecting a channel number.

Notes:

- Refer to the manual supplied with your TV.
- You cannot change the channels of some TVs by pressing number buttons. In this case, press CHANNEL +/- for changing the channels.

- Try to operate your TV by pressing TV/CATV/DBS POWER.

When your TV turns on or off, you have entered the correct code. If there are more than one code listed for your brand of TV, try each one until the correct one is entered.

Continued to the next page.

To change the transmittable signals for operating a CATV converter and DBS tuner

1. Set TV/CATV/DBS selector to "CATV/DBS."
2. Press and hold TV/CATV/DBS POWER.
3. Press TV/DBS.
4. Enter manufacturer's code using buttons 1–9, and 0.

See pages 70 and 71 to find the code.

5. Release TV/CATV/DBS POWER.

After setting TV/CATV/DBS selector to "CATV/DBS," you can turn on and off the CATV converter or on the DBS tuner:

TV/CATV/DBS POWER: Turns on and off the CATV converter or DBS tuner.

After pressing TV/DBS with TV/CATV/DBS selector set to "CATV/DBS," you can perform the following operations on the CATV converter or on the DBS tuner:

CHANNEL +/-: Changes the channels.
1 – 10, 0, 100+ (+10): Selects the channels.
The 10 button will function as the ENTER button if your equipment requires pressing ENTER after selecting a channel number.

Note:

Refer to the manual supplied with your CATV converter or DBS tuner.

6. Try to operate your CATV converter or DBS tuner by pressing TV/CATV/DBS POWER.

When your CATV converter or DBS tuner turns on or off, you have entered the correct code.

If there are more than one code listed for your brand of CATV converter or DBS tuner, try each one until the correct one is entered.

Note:

You cannot use both of the CATV converter and DBS tuner at the same time.

To change the transmittable signals for operating another manufacturer's VCR

1. Press and hold VCR 1 POWER.
2. Press VCR 1.
3. Enter manufacturer's code using buttons 1–9, and 0.

See page 71 to find the code.

4. Release VCR 1 POWER.

The following button can be used for operating the VCR :

VCR 1 POWER: Turns on and off the VCR.

After pressing VCR 1, you can perform the following operations on the VCR:

CHANNEL +/-: Changes the TV channels on the VCR.
1 – 10, 0, 100+ (+10): Selects the TV channels.
The 10 button will function as the ENTER button if your VCR requires pressing ENTER after selecting a channel number.
PLAY: Starts playback.
REW: Rewinds a video tape.
FF: Fast-winds a video tape.
STOP: Stops operation.
PAUSE: Pauses.
● REC and PAUSE: Enters recording pause (for the main room only).
● REC and PLAY: Starts recording (for the main room only).

Note:

Refer to the manual supplied with your VCR.

5. Try to operate your VCR by pressing VCR 1 POWER.

When your VCR turns on or off, you have entered the correct code.

If there are more than one code listed for your brand of VCR, try each one until the correct one is entered.

To change the transmittable signals for operating a DVD player

1. Press and hold VCR 1 POWER.
2. Press DVD.
3. Enter manufacturer's code using buttons 1–9, and 0.
4. Release VCR 1 POWER.

After pressing DVD or DVD MULTI, you can perform the following operations on a DVD player:

1 – 9, 0: Selects the titles or the tracks.
PLAY: Starts playing.
◀◀: Returns to the beginning of the current (or previous) track.
▶▶: Skips to the beginning of the next track.
STOP: Stops playing.
PAUSE: Stops playing temporarily. To release it, press PLAY.

After pressing DVD MENU (only for the main room operations), these buttons can be used for the DVD menu operations.

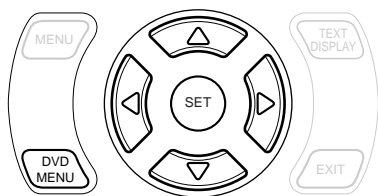

Note:

For detailed menu operations, refer to the instructions supplied with the discs or the DVD player.

Note:

Refer to the manual supplied with your DVD player.

5. Try to operate your DVD player by pressing one of the above buttons.

- DO NOT forget to turn on the DVD player before pressing one of the above buttons.

If there are more than one code listed for your brand of DVD player, try each one until the correct one is entered.

To change the transmittable signals for operating a CD player

1. Press and hold AUDIO POWER ON.
2. Press CD.
3. Enter manufacturer's code using buttons 1-9, and 0.

See page 71 to find the code.

4. Release AUDIO POWER ON.

After pressing CD (with the remote control mode selector set to "TV"), you can perform the following operations on a CD player:

- 1 - 9, 0, +10: Selects the tracks.
- PLAY: Starts playing.
- ◀◀: Returns to the beginning of the current (or previous) track.
- ▶▶: Skips to the beginning of the next track.
- STOP: Stops playing.
- PAUSE: Stops playing temporarily. To release it, press PLAY.

Note:

Refer to the manual supplied with your CD player.

5. Try to operate your CD player by pressing one of the above buttons.

- DO NOT forget to turn on the CD player before pressing one of the above buttons.

If there are more than one code listed for your brand of CD, try each one until the correct one is entered.

Manufactures' codes for TV

Manufacturer	Codes
JVC	00*, 14, 74
FISHER	05
HITACHI	08, 09, 10, 49
MAGNAVOX	08, 17, 49
METS	50, 51, 52, 53
MITSUBISHI	08, 18
PANASONIC	24, 26, 76
PHILIPS	17
QUELLE	52, 53, 54, 55, 56, 57, 58, 59, 60, 61, 62, 63, 64, 65, 66, 67
RCA/PROSC	08, 24, 29, 30, 31, 48
SAMSUNG	08, 34, 49
SANYO	05
SHARP	38, 77
SONY	39
TOSHIBA	37, 43
ZENITH	45, 46

*This figure is set to the remote control as the initial JVC cord.

Manufactures' codes for DBS tuner

Manufacturer	Codes
JVC	56, 57*, 67
AMSTRAD	43, 44, 45, 46, 47, 48, 49
BLAUPUNKT	30
ECHOSTAR	50, 51, 67
GOLDSTAR	31
GRUNDIG	32, 33
HIRSHMANN	48, 52, 53, 54, 55
INSTRUMENT	68
ITT/NOKIA	34
KATHREIN	52, 58, 59, 60, 61, 62, 63
NEC	35, 36
ORBITECH	48
PHILIPS	37, 38
RCA	65
SAMSUNG	39, 40
SCHWAIGER	61, 64
SIEMENS	41, 42
SONY	66
TECHNISAT	48

*This figure is set to the remote control as the initial JVC cord.

Note:

Manufacturers' codes are subject to change without notice. If they are changed, this remote control cannot operate the equipment.

Continued to the next page.

Manufactures' codes for CATV converter

Manufacturer	Codes
GENERAL INSTRUMENT	29
HAMLIN/RE	01, 02, 03, 04, 05
JERROLD/G	06, 07, 08, 09, 10, 11, 12, 13, 14
OAK	15, 16, 17
PANASONIC	18, 19, 20
PIONEER	21, 22
SCIENTIFF	23, 24, 25
TOCOM	26
ZENITH	27, 28

Manufactures' codes for DVD player

Manufacturer	Codes
JVC	00*, 02
DENON	01
PANASONIC	03
PHILIPS	13
PIONEER	04, 05, 06
RCA	07
SAMSUNG	08
SONY	09
TOSHIBA	10
YAMAHA	11, 12

*This figure is set to the remote control as the initial JVC cord.

Manufactures' codes for VCR

Manufacturer	Codes
JVC	00*, 26, 27
AIWA	01
BELL & HOWELL	03
EMERSON	08, 10, 11, 12, 64, 65
FISHER	03, 14, 15, 16
FUNAI	01
GE	18, 19, 20
GOLDSTAR	07
HITACHI	18, 23, 24
MAGNAVOX	04, 19, 24
mitsubishi	30, 31, 32, 33
NEC	26, 27
PANASONIC	19, 24, 39
PHILIPS	19, 24
RCA/PROSC	04, 18, 19, 23, 24, 43, 44, 45
SAMSUNG	45, 61, 62
SANYO	03, 48
SHARP	37, 50
SONY	52, 53, 54
TOSHIBA	43, 44
ZENITH	56, 57

*This figure is set to the remote control as the initial JVC cord.

Manufactures' codes for CD player

Manufacturer	Codes
JVC	00*, 06, 07, 08
DENON	01, 03
FISHER	04
KENWOOD	10, 11, 12
MAGNAVOX	15, 16
MARANTZ	17
ONKYO	18, 20, 21
PANASONIC	22, 24
PHILIPS	25, 26, 29
PIONEER	30
RCA	32, 33, 34
SANYO	35
SHARP	36
SONY	53
TEAC	37, 38, 39
TECHNICS	40, 41, 42, 45
YAMAHA	46, 47, 48

*This figure is set to the remote control as the initial JVC cord.

Note:

Manufacturers' codes are subject to change without notice. If they are changed, this remote control cannot operate the equipment.

Troubleshooting

Use this chart to help you solve daily operational problems. If there is any problem you cannot solve, contact your JVC service center.

PROBLEM	POSSIBLE CAUSE	SOLUTION
The display does not light up.	The power cord is not plugged in.	Plug the power cord into an AC outlet. (See page 13.)
The buttons and controls on the front panel do not work.	The Multi-room function is not set correctly.	<ul style="list-style-type: none"> Press MAIN ROOM ON/OFF for the main room operations. Press SUB ROOM ON/OFF and SUB ROOM CONTROL for the sub-room operations.
No sound from the speakers in the main room.	Speaker signal cables are not connected properly.	Check speaker wiring and reconnect if necessary. (See pages 6 and 7.)
	The SPEAKERS ON/OFF 1 and SPEAKERS ON/OFF 2 buttons are not set correctly.	Press SPEAKERS ON/OFF 1 and SPEAKERS ON/OFF 2 correctly. (See page 19.)
	An incorrect source is selected for the main room.	Select the correct source for the main room.
	Muting is activated for the main room source.	Press MUTING to cancel the mute. (See page 21.)
	An incorrect input mode (analog or digital) is selected.	Select the correct input mode (analog or digital). (See page 31.)
	Connections are incorrect.	Check connections. For analog corrections, see page 7. For digital corrections, see page 10. For USB connection, see page 11.
No sound from the front speakers in the sub-room.	Speaker signal cables are not connected properly.	Check speaker connection and reconnect if necessary. (See page 14.)
	Main/sub setting for the speakers connected to the FRONT 2/SUB ROOM terminals are not set correctly.	Set the main/sub setting for the speakers correctly to use them as the sub-room front speakers. (See page 27.)
	Amplifier connected to the SUB ROOM PRE OUT is not turned on.	Turn on the amplifier.
	An incorrect source is selected for the sub-room.	Select the correct sub-room source.
	Muting is activated for the sub-room source.	Press MUTING to cancel the mute. (See page 26.)
	Connections are incorrect.	Check connections. For analog corrections, see page 7. For USB connection, see page 11.
Sound from one speaker only in the main room.	Speaker signal cables are not connected properly.	Check speaker connection and reconnect if necessary. (See page 14.)
	The balance is set to one extreme.	Adjust the balance properly (see page 27).
The SUB ROOM ON/OFF button does not work.	The Surround/DSP mode is used for the main room.	Cancel the Surround/DSP mode in the main room.
Surround cannot be used for the main room sources.	Sub-room sound is activated (the SUB ROOM indicator and SPEAKERS SUB ROOM indicator are lit on the display).	Deactivating the sub-room sound will allow you to use the Surround in the main room.
CD tracks are skipped, tape is rewind, or radio station is changed unintentionally.	When the same source is selected both for the main room and the sub-room, the source in one room affects the source in the other room.	This is normal, not the malfunction of the unit. Selecting different sources for the main room and the sub-room will avoid these troubles.
The receiver does not work correctly as you operate it.	Main room and sub-room operations are done at the same time.	If this happens, perform the same operation again.
Noise is heard.	An earth (⏏) cable is not connected to the AM (⏏) terminal on the rear panel.	Connect the cable to the AM (⏏) terminal on the rear panel.

Continued to the next page.

PROBLEM	POSSIBLE CAUSE	SOLUTION
Continuous hiss or buzzing during FM reception.	Incoming signal is too weak.	Connect an outdoor FM antenna or contact your dealer. (See page 5.)
	The station is too far away.	Select a new station.
	An incorrect antenna is used.	Check with your dealer to be sure you have the correct antenna.
	Antennas are not connected properly.	Check connections. (See page 5.)
Occasional cracking noise during FM reception.	Ignition noise from automobiles.	Move the antenna farther from automobile traffic.
Howling during record playing.	Your turntable is too close to speakers.	Move speakers away from the turntable.
No sound from PC connected with a USB cable.	An electrical shock is applied to the receiver, PC, or USB cable.	Turn off and on the receiver once, then restart the application installed in the PC.
	USB device is not selected on the computer.	Select "USB Audio Device [1]" for "Playback" of "Audio" (see page 11). Refer to the manuals supplied with your PC.
	"MUTE" is selected on the PC.	Check if the volume is set at low level. Refer to the manuals supplied for your PC.
Noise while reproducing PC sound connected with a USB cable.	Strong electromagnetic wave is emitted from such as television.	Move your PC away from the device emitting strong electromagnetic wave.
Sound from PC connected with a USB cable stops intermittently.	PC is subjected to excessive load due to using other applications.	Close the applications you do not use.
No sound effect such as DSP mode and digital equalization.	The Line Direct function is turned on.	Turn off the Line Direct function. (See page 22.)
"OVERLOAD" starts flashing on the display.	Speakers are overloaded because of high volume either in the main room or in the sub-room.	<ol style="list-style-type: none"> 1. Press POWER on the front panel to turn off the receiver. 2. Stop the playback source. 3. Turn on the receiver again, and adjust the volume.
	Speakers are overloaded because of short circuit of speaker terminals.	Press POWER on the front panel to turn off the receiver, check the speaker wiring, then press it again to turn on the receiver again. If "OVERLOAD" does not disappear despite speaker wiring is not short-circuited, consult your dealer.
"TURN ON MAIN OR SUB ROOM" appears on the display.	The receiver is turned on with the main room and sub-room sounds deactivated.	<ul style="list-style-type: none"> • Press MAIN ROOM ON/OFF for the main room operations. • Press SUB ROOM ON/OFF for the sub-room operations.
The STANDBY lamp lights up after turning on the power, but soon the receiver turns off again (into standby mode).	The receiver is overloaded because of applying high voltage.	Press POWER on the front panel to turn off the receiver. After unplugging the AC power cord, consult your dealer.
Remote control does not work.	The MAIN ROOM/SUB ROOM selector is not set correctly.	Set the selector correctly either to "MAIN ROOM" or to "SUB ROOM."
	The TV/CATV/DBS selector is not set correctly.	Set the selector correctly either to "TV" or to "CATV/DBS."
	RF communication between the receiver and the remote control is interrupted from outside.	Consult your dealer.
	Batteries are weak.	Replace batteries. (See page 13.)
Remote control does not work properly.	An incorrect remote control operation mode is selected.	Select the correct remote control operation mode. (See page 65.)

Specifications

Amplifier

Output Power

At Stereo operation:

Front channels: **120 W per channel, min. RMS, driven into 8 Ω, 20 Hz to 20 kHz with no more than 0.02% total harmonic distortion.**

120 W per channel, min. RMS, driven into 4 Ω, 20 Hz to 20 kHz with no more than 0.08% total harmonic distortion.

At Surround operation:

Front channels: 100 W per channel, min. RMS, driven into 8 Ω at 1 kHz with no more than 0.8% total harmonic distortion.

Center channel: 100 W, min. RMS, driven into 8 Ω at 1 kHz, with no more than 0.8% total harmonic distortion.

Rear channels: 100 W per channel, min. RMS, driven into 8 Ω at 1 kHz, with no more than 0.8% total harmonic distortion.

Audio

Audio Input Sensitivity/Impedance (1 kHz):

PHONO (MM): 2.5 mV/47 kΩ

DVD, VCR 1, VCR 2, VIDEO, TV SOUND/DBS, CD, CDR, TAPE/MD: 200 mV/47 kΩ

Audio Input (DIGITAL IN)* :

Coaxial: DIGITAL 1 (DVD): 0.5 V(p-p)/75 Ω

Optical: DIGITAL 2 (CD), DIGITAL 3 (TV), DIGITAL 4 (CDR): -21 dBm to -15 dBm (660 nm ±30 nm)

* Corresponding to Linear PCM, Dolby Digital, and DTS Digital Surround (with sampling frequency — 32 kHz, 44.1 kHz, 48 kHz).

USB:Revision 1.0, Full-speed (with sampling frequency — 32 kHz, 44.1 kHz, 48 kHz)

Audio Output Level:

SUB ROOM PRE OUT: 200 mV

Recording Output Level: TAPE/MD, VCR 1, VCR 2, CDR: 200 mV

Digital output: Optical: DIGITAL OUTPUT
Signal wave length: 660 nm
Output level: -21 dBm to -15 dBm

Signal-to-Noise Ratio (66 IHF/78 IHF):

PHONO: 70 dB/78 dB (at REC OUT)

DVD, VCR 1, VCR 2, VIDEO, TV SOUND/DBS, CD, CDR, TAPE/MD: 92 dB/80 dB (Line Direct On)

Frequency Response (8 Ω):

PHONO: 20 Hz to 20 kHz (±1 dB)

VCR 1, VCR 2, VIDEO, TV SOUND/DBS, CD, CDR, TAPE/MD, DVD CENTER, DVD REAR, DVD FRONT : 20 Hz to 20 kHz (±1 dB, -3 dB)

USB : 20 Hz to 20 kHz (±1 dB, -3 dB)

RIAA Phono Equalization: ±1.0 dB (20 Hz to 20 kHz)

Bass boost (Volume control at -30 dB): +6 ±1.0 dB at 100 Hz

Video

Video Input Sensitivity/Impedance:

Composite video: DVD, VCR 1, VCR 2, VIDEO, TV SOUND/DBS: 1 V(p-p)/75 Ω

S-video: DVD, VCR 1, VCR 2, VIDEO, TV SOUND/DBS: (Y: luminance): 1 V(p-p)/75 Ω

(C: chrominance, burst): 0.286 V(p-p)/75 Ω

Component: DVD, DBS

(Y: luminance): 1 V(p-p)/75 Ω

(P_B, P_R): ±0.7 V/75 Ω

Video Output Level:

Composite video: VCR 1, VCR 2, MONITOR OUT: 1 V(p-p)/75 Ω

S-video: VCR 1, VCR 2, MONITOR OUT:

(Y: luminance): 1 V(p-p)/75 Ω

(C: chrominance, burst): 0.286 V(p-p)/75 Ω

Component: MONITOR OUT

(Y: luminance): 1 V(p-p)/75 Ω

(P_B, P_R): ±0.7 V/75 Ω

Synchronization: Negative

Signal-to-Noise Ratio: 45 dB

On-Screen Color System: NTSC

FM tuner (IHF)

Tuning Range: 87.5 MHz to 108.0 MHz

Usable Sensitivity: Monaural: 12.8 dBf (1.2 μV/75 Ω)

50 dB Quieting Sensitivity:

Monaural: 21.3 dBf (3.2 μV/75 Ω)

Stereo: 41.3 dBf (31.5 μV/75 Ω)

Signal-to-Noise Ratio (IHF-A weighted):

Monaural: 78 dB at 85 dBf

Stereo: 73 dB at 85 dBf

Total Harmonic Distortion:

Monaural: 0.4% at 1 kHz

Stereo: 0.6% at 1 kHz

Stereo Separation at REC OUT: 35 dB at 1 kHz

Alternate Channel Selectivity: 45 dB: (±400 kHz)

Frequency Response: 30 Hz to 15 kHz: (+0.5 dB, -3 dB)

AM tuner

Tuning Range: 530 kHz to 1 710 kHz

Usable Sensitivity: Loop antenna: 400 μV/m

Signal-to-Noise Ratio: 50 dB (100 mV/m)

General

Power Requirements: AC 120V[~], 60 Hz

Power Consumption: 320 W/440 VA (at operation)
2 watts (in standby mode)

Dimensions (W x H x D): 435 mm x 156.5 mm x 425.1 mm
(17³/₁₆ in. x 6³/₁₆ in. x 16³/₄ in.)

Mass: 11.6 kg (25.6 lbs)

HOW TO LOCATE YOUR JVC SERVICE CENTER

TOLL FREE : 1-800-537-5722

<http://www.jvcservice.com>

Dear customer:

In order to receive the most satisfaction from your purchase, read the instruction booklet before operating the unit. In the event that repair is necessary, or for the address nearest your location, please refer to the factory service center list below or within the Continental United States, Call 1-800-537-5722 for your authorized servicer. Remember to retain your Bill of Sale for Warranty Service.

—JVC

JVC SERVICE & ENGINEERING COMPANY OF AMERICA DIVISION OF JVC AMERICAS CORP.

FACTORY SERVICE CENTER LOCATIONS

10 New Maple Avenue
Pine Brook, NJ 07058-9641
(973) 396-1000

1500 Lakes Parkway
Lawrenceville, GA 30243-5857
(770) 339-2582

705 Enterprise Street
Aurora, IL 60504-8149
(630) 851-7855

5665 Corporate Avenue
Cypress, CA 90630-0024
(714) 229-8011

2969 Mapunapuna Place
Honolulu, HI 96819-2040
(808) 833-5828

10700 Hammerly, Suite 110
Houston, TX 77043
(713) 935-9331

13 Cummings Park
Woburn, MA 01801
(781) 376-9100

8192 State Road 84
Davie, FL 33324
(954) 472-1960

890 Dubuque Avenue
South San Francisco, CA 94080-1804
(650) 871-2666

Sophisticated electronic products may require occasional service. Just as quality is a keyword in the engineering and production of the wide array of JVC products, service is the key to maintaining the high level of performance for which JVC is world famous. The JVC service and engineering organization stands behind our products.

NATIONAL HEADQUARTERS
JVC SERVICE & ENGINEERING COMPANY OF AMERICA
DIVISION OF JVC AMERICAS CORP.
1700 Valley Road
Wayne, NJ 07470

If you ship the product •••

Pack your JVC unit in the original carton or one of equivalent size and strength. Enclose, with the unit, a letter stating the problem or symptom that exists and also a copy of the receipt or bill of sale you received when you purchased your JVC unit. Print your home return address on the outside and the inside of the carton. Send to the appropriate JVC Factory Service Center as listed above.

Don't service it yourself.

CAUTION

*To prevent electrical shock, do not open the cabinet. No user serviceable parts inside.
Refer servicing to qualified service personnel.*

ACCESSORIES

To purchase accessories for your JVC product, you may contact your local JVC Dealer. Or from the 48 Continental United States call toll free : 800-882-2345



LIMITED WARRANTY AUDIO-2

JVC COMPANY OF AMERICA warrants this product and all parts thereof, except as set forth below ONLY TO THE ORIGINAL PURCHASER AT RETAIL to be FREE FROM DEFECTIVE MATERIAL AND WORKMANSHIP from the date of original retail purchase for the period as shown below. ("The Warranty Period.")

PARTS	LABOR
2YR	2YR

THIS LIMITED WARRANTY IS VALID ONLY IN THE FIFTY(50) UNITED STATES, THE DISTRICT OF COLUMBIA AND IN COMMONWEALTH OF PUERTO RICO.

WHAT WE WILL DO:

If this product is found to be defective, JVC will repair or replace defective parts at no charge to the original owner. Such repair and replacement services shall be rendered by JVC during normal business hours at JVC authorized service centers. Parts used for replacement are warranted only for the remainder of the Warranty Period. All products and parts thereof may be brought to a JVC authorized service center on a carry-in basis except for Television sets having a screen size 25 inches and above which are covered on an in-home basis.

WHAT YOU MUST DO FOR WARRANTY SERVICE:

Return your product to a JVC authorized service center with a copy of your bill of sale. For your nearest JVC authorized service center, please call toll free: (800)537-5722. If service is not available locally, box the product carefully, preferably in the original carton, and ship, insured, with a copy of your bill of sale plus and letter of explanation of the problem to the nearest JVC Factory Service Center, the name and location of which will be given to you by the toll-free number. If you have any questions concerning your JVC Product, please contact our Customer Relations Department.

WHAT IS NOT COVERED:

- This limited warranty provided by JVC does not cover:
1. Products which have been subject to abuse, accident, alteration, modification, tampering, negligence, misuse, faulty installation, lack of reasonable care, or if repaired or serviced by anyone other than a service facility authorized by JVC to render such service, or if affixed to any attachment not provided with the products, or if the model number or serial number has been altered, tampered with, defaced or removed;
 2. Initial installation and installation and removal for repair;
 3. Operational adjustments covered in the Owner's Manual, normal maintenance, video and audio head cleaning;
 4. Damage that occurs in shipment, due to act of God, and cosmetic damage;
 5. Signal reception problems and failures due to line power surge;
 6. Video Pick-up Tubes/CCD Image Sensor, Cartridge, Stylus(Needle) are covered for 90 days from the date of purchase;
 7. Accessories;
 8. Batteries (except the Rechargeable Batteries are covered for 90 days from the date of purchase);

There are no express warranties except as listed above.

THE DURATION OF ANY IMPLIED WARRANTIES, INCLUDING THE IMPLIED WARRANTY OF MERCHANTABILITY, IS LIMITED TO THE DURATION OF THE EXPRESS WARRANTY HEREIN.

JVC SHALL NOT BE LIABLE FOR THE LOSS OF USE OF THE PRODUCT, INCONVENIENCE, LOSS OR ANY OTHER DAMAGES, WHETHER DIRECT, INCIDENTAL OR CONSEQUENTIAL (INCLUDING, WITHOUT LIMITATION, DAMAGE TO TAPES, RECORDS OR DISCS) RESULTING FROM THE USE OF THIS PRODUCT, OR ARISING OUT OF ANY BREACH OF THIS WARRANTY. ALL EXPRESS AND IMPLIED WARRANTIES, INCLUDING THE WARRANTIES OF MERCHANTABILITY AND FITNESS FOR PARTICULAR PURPOSE, ARE LIMITED TO THE WARRANTY PERIOD SET FORTH ABOVE.

Some states do not allow the exclusion of incidental or consequential damages or limitations on how long an implied warranty last, so these limitations or exclusions may not apply to you. This warranty gives you specific legal rights and you may also have other rights which vary from state to state.

JVC COMPANY OF AMERICA
DIVISION OF JVC AMERICAS CORP.

1700 Valley Road
Wayne, NJ 07470

REFURBISHED PRODUCTS CARRY A SEPARATE WARRANTY, THIS WARRANTY DOES NOT APPLY. FOR DETAILS OF REFURBISHED PRODUCT WARRANTY, PLEASE REFER TO THE REFURBISHED PRODUCT WARRANTY INFORMATION PACKAGED WITH EACH REFURBISHED PRODUCT.

For customer use:

Enter below the Model No. and Serial No. which is located either on the rear, bottom or side of the cabinet. Retain this information for future reference.

Model No.: _____

Serial No.: _____

Purchase date: _____

Name of dealer: _____

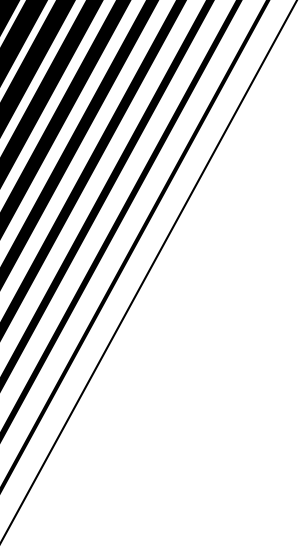

JVC
VICTOR COMPANY OF JAPAN, LIMITED